

◎本目录所有参数仅供参考，如有变动不另行通知，以实物为准。  
◎All the parameters in this catalogue are for reference only.



宁波赛顺塑料电器有限公司  
NINGBO SAISHUN PLASTIC ELECTRICAL APPLIANCE CO.,LTD.

地址：浙江省宁波市奉化区莼湖街道滨海新区滨海大道398号  
ADD: No. 398, Binhai Avenue, Binhai, Chunhu Street,  
Fenghua District, Ningbo, Zhejiang  
电话：0574 - 88881001 88931748  
Tel: 0574 - 88881001 88931748  
传真：0574 - 88926248  
FAX: 0574 - 88926248  
E - mail: wxm5419@saishun.com  
Http://www.saishun.com

## 电气连接与保护系统

Connection & Protections



宁波赛顺塑料电器有限公司

NINGBO SAISHUN PLASTIC ELECTRICAL APPLIANCE CO.,LTD.

宁波通冠电气自动化设备有限公司

NINGBO TONGGUAN ELECTRICAL AUTOMATION EQUIPMENT CO.,LTD.

中国·宁波  
NINGBO·CHINA





宁波赛顺塑料电器有限公司，最早成立于1997年，是一家专业从事电气连接与保护相关产品的研发、生产和销售的专业性企业，2011年全资投资成立了宁波通冠电气自动化设备有限公司，是一家专业从事防水透气薄膜和新材料涂层高新技术企业，团队还多次承担并完成省市级新材料技术攻关任务。

主要产品有电缆防水接头、软管及软管接头、拖链、连接器、防水透气膜、新材料功能涂层材料等，广泛应用于通信通讯、光伏风能、储能、轨道交通、新能源汽车、电气机械、航天航空、电工电子等领域，产品远销亚洲、欧洲、南美、北美和大洋洲等地区。

公司以“新材料+智能”为核心理念，积极布局5G通信、排放后处理、智能安防、无人驾驶、新能源动力保护、储能等新领域技术研发，面向基础通讯、汽车工业、电力工业、储能逆变等领域的关键设备提供持续长效的防护。公司新材料研发团队，自2005年开始从事ePTFE、PTC+碳基相关材料领域研发，经过近8年的沉淀，已经陆续开发了多个领域的创新和应用，已申报各类专利共67项，其中发明专利10项，已授权55项；主要产品通过了CE认证，符合欧盟ROHS、REACH要求，部分产品通过了铁路EN45545认证、ATEX/IECEX防爆认证。在奉化经济开发区建有45000平方米的生产基地，建有两个10万级部分万级的洁净生产车间，加工生产车间配置各类全自动精密加工机床、全自动注塑、组装检测系统；在上海设有研发中心、深圳设有办事处和工程中心，更好更快的为客户提供质高价优的赛顺产品。

在“中国制造2025”的发展背景下，宁波赛顺通过技术与产业的紧密结合，实现以智能新材料技术进步推动工业领域制造和管理运营效益提升的发展愿景，努力成为基础制造和材料技术创新的引领者。

Ningbo Saishun Plastic Electrical Appliance Co., Ltd., first established in 1997, is a professional engaged in electrical connection and protection related products research and development, production and sales of professional enterprises, in 2011 wholly invested in the establishment of Ningbo Tongguan Electrical Automation Equipment Co., Ltd., is a professional engaged in waterproof and breathable film and new material coating high-tech enterprises, the team also undertake and complete provincial and municipal new material technology research tasks for many times. The main products are cable waterproof joints, hoses and hose joints, energy chains, connectors, waterproof and breathable films, new material functional coating materials, etc., which are widely used in communications, photovoltaic wind energy, energy storage, rail transit, new energy vehicles, electrical machinery, aerospace, electrical electronics and other fields, and the products are exported to Asia, Europe, South America, North America and Oceania and other regions.

With the core concept of "new materials + intelligence", the company actively lays out 5G communication, emission post-treatment, intelligent security, unmanned driving, new energy power protection, energy storage and other new fields of technology research and development, and provides continuous and long-term protection for key equipment in the fields of basic communications, automotive industry, power industry, and energy storage inverter. The company's new material research and development team, since 2005 engaged in ePTFE, PTC+ carbon-based related materials research and development, after nearly 8 years of precipitation, has successively developed a number of fields of innovation and application, has declared a total of 67 patents, including 10 invention patents, has been authorized 55; The main products have passed CE certification, in line with the EU ROHS, REACH requirements, some products have passed railway EN45545 certification, ATEX/IECEX explosion-proof certification. In Fenghua Economic Development Zone, there is a production base of 45,000 square meters, two clean production workshops of 100,000 levels and 10,000 levels, and the processing and production workshops are equipped with various automatic precision processing machine tools, automatic injection molding and assembly testing systems; It has a R & D center in Shanghai and an office and an engineering center in Shenzhen to provide customers with high-quality and high-cost Saishun products better and faster.

Under the development background of "Made in China 2025", Ningbo Saishun realizes the development vision of promoting the improvement of manufacturing and management operation efficiency in the industrial field with the progress of intelligent new material technology through the close integration of technology and industry, and strives to become a leader in basic manufacturing and material technology innovation.





# CONTENT

## 目 录

### 企业简介company profile

#### 一. 电缆防水接头系列 Cable Gland Series

##### 塑料篇 Plastic

1.塑料电缆防水接头 Nylon Cable Gland .....	01
2.多孔塑料电缆防水接头 Nylon Cable Gland with Multi-holes .....	05
3.塑料线缆防折接头 Anti-fold Nylon Cable Gland .....	07
4.塑料闷盖 Nylon Screw Plug.....	08
5.塑料减缩环 Nylon reducer.....	09
6.塑料增扩环 Nylon Enlarger.....	10
7.塑料螺母 Nylon Lock nuts .....	11

##### 金属篇 Metal

1.金属电缆防水接头Metal Cable Gland.....	13
2.电磁兼容金属电缆防水接头 Electromagnetic Cable Gland .....	15
3.多孔金属电缆防水接头 Metal Cable Gland with Multi-holes .....	17
4.圆形金属闷盖 Metal Screw Plug .....	19
5.六角形金属闷盖Hexagon Metal Screw Plug .....	20
6.金属变径接头 Metal Reducer & Enlarger Connector .....	21
7.不锈钢电缆防水接头 Stainless Steel Cable Gland .....	22
8.金属螺母 Metal Lock nuts .....	26

#### 二: 塑料波纹软管及接头系列 Plastic Flexible Conduit & Fitting

1.尼龙波纹软管 Nylon Flexible Conduit .....	28
2.阻燃V0尼龙波纹软管 Fire resistant UL94-V0 Nylon Flexible Conduit .....	29
3.阻燃V2尼龙波纹软管 Fire resistant UL94-V2 Nylon Flexible Conduit .....	30
4.耐高温尼龙波纹软管 Nylon High Temperature resistant conduit .....	31
5.剖开型尼龙软管 Slit Nylon Flexible Conduit .....	32
6.尼龙12软管 Nylon12 Flexible Conduit .....	33
7.阻燃尼龙12软管 Fire resistant UL94-V2 Nylon12 Flexible Conduit .....	34
8.聚乙烯波纹软管 PE Flexible Conduit .....	35
9.阻燃型聚乙烯波纹软管 Fire resistant PE Flexible Conduit.....	36
10.剖开型聚乙烯软管 Slit PE Flexible Conduit.....	37
11.聚丙烯波纹软管 PP Flexible Conduit.....	38
12.阻燃型聚丙烯波纹软管 Fire resistant PP Flexible Conduit .....	39
13.剖开型聚丙烯软管 Slit PP Flexible Conduit .....	40
14.尼龙双拼波纹软管 Nylon Double Flexible Conduit .....	41

#### 软管接头及配件 Fitting &Accessory

1.快插式软管接头 Straight Quick Fitting .....	45
2.直角快插式软管接头 Elbow Quick Fitting .....	47
3.45°快插式软管接头 45 Degree Quick Fitting .....	48
4.可开式V型快插式软管接头 Y Quick Fitting.....	49
5.法兰式大口径软管接头 Flange Conduit Fitting.....	49
6.Y型三通接头 Operable Y distributor .....	50
7.直角法兰式大口径软管接头 90 Deg Flange Conduit Fitting.....	50
8.拧紧式软管接头 Screw Fitting .....	51
9.内螺纹快插式接头 Inner Thread Quick Fitting .....	52
10.卡套式快插接头Ferrule Quick Fitting.....	53
11.金属螺纹接头 Metal Thread Fitting .....	53
12.90°金属螺纹接头90°Metal Thread Fitting .....	54
13.45°金属螺纹接头45°Metal Thread Fitting .....	55
14.金属内螺纹软管接头 Metal Inner Thread Quick Fitting.....	56
15.锁紧式软管接头 With cable gland conduit fitting .....	57
16.金属锁紧式软管接头 With metal cable gland conduit fitting.....	58
17.软管支架 Conduit Clip.....	59
18.防水型软管接头 Waterproof hose connector .....	60
19.90度防水型软管接头 90° Waterproof hose connector.....	61

#### 三. 金属软管及接头 Metal Flexible Conduit & Fitting

1.金属包塑软管 PVC Coated Metal Flexible Conduit .....	63
2.金属软管Galvanized Metal Flexible Conduit.....	64
3.平包塑软管 Smooth PVC Coated Metal Conduit .....	65
2.端接式接头DPJ Type Liquid tight Connector.....	66
4.卡套式接头DKJ Clamp Type Rigid to Liquid tight .....	67
5.内螺纹接头DPN Compression Type Fit for BSP(G)Thread .....	67
6.卡簧式接头DGJ Clamp Type Rigid to Liquid tight .....	68
7.90°弯接头DWJ Type Liquid tight Connector .....	68
8.45°弯接头DWJ 45 Degree Liquid tight Connector.....	69
9.Y型三通接头 DPY Y type Liquid tight Connector .....	69
10.黄铜镀镍固定式接头 Brass Plated Nickel fixed fitting .....	70
11.黄铜镀镍旋转式接头 Brass Plated Nickel swivel fitting.....	70

#### 四. 塑料工程拖链 Plastic Cable Drag Chain .....

#### 五. 散热防水透气阀 Breathable Vent Plug .....

#### 六. 塑料冷却水管 Cooling Tube.....





### 电缆防水接头系列 Cable Gland Series

塑料篇 Plastic

金属篇 Metal

塑料波纹管及接头系列 Plastic Flexible Conduit & Fitting

软管接头及附件 Fitting & Accessory

金属软管及接头 Metal Flexible Conduit & Fitting

塑料工程拖链 Plastic Cable Drag Chain

散热防水透气阀 Breathable Vent Plug

塑料冷却水管 Cooling Tube

## SSG系列

### 塑料电缆防水接头 Nylon Cable Gland

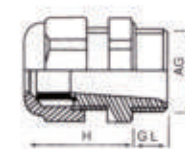

材料: PA6, 密封件材料: 丁晴橡胶  
 防护等级: 在规定的卡口范围内, 并使用合适的O形密封圈, 防护等级可以达到IP68  
 温度范围: 静态: -40°C到100°C, 短时间可以达到120°C  
 动态: -20°C到80°C, 短时间可以达到100°C  
 颜色: 黑色 (RAL9005) /灰白色 (9018) /深灰色 (7037)

Material: PA6, Sealing: NBR  
 Protection degree: Using suitable O-sealing within the clamping range, The protection degree can reach IP68  
 Temperature Range: Stat.: Min-40°C, Max100°C, Short-term120°C  
 Dyn.: Min-20°C, Max80°C, Short-term100°C  
 Color: Black(RAL9005)/White Gray(RAL9018)/Dark Gary(RAL7037)

### SSG-M 公制螺纹 Metric Thread

订货编号 Article	螺纹规格 Thread Dimension	卡口范围 Clamping range mm	螺纹外径 AG mm	螺纹长度 GL mm	扳手尺寸 Wrench size mm	包装单位 Packet units
SSG-M8(B/G/W)	M8x1.25	2.5-4.5	8	8	13.5	100
SSG-M12 (B/G/W)	M12x1.5	3-6.5	12	8.5	15	100
SSG-M16-X (B/G/W)	M16x1.5	3-6.5	16	8.5	19	100
SSG-M16 (B/G/W)	M16x1.5	4-8	16	8	19	100
SSG-M16-D (B/G/W)	M16x1.5	5-10	16	8	22	100
SSG-M18 (B/G/W)	M18x1.5	5-10	18	8	22	100
SSG-M20-X (B/G/W)	M20x1.5	5-10	20	10	24	100
SSG-M20 (B/G/W)	M20x1.5	6-12	20	10	24	100
SSG-M20-D (B/G/W)	M20x1.5	10-14	20	10	27	50
SSG-M22-X (B/G/W)	M22x1.5	6-12	22	10	27	50
SSG-M22 (B/G/W)	M22x1.5	10-14	22	10	27	50
SSG-M24-X (B/G/W)	M24x1.5	6-12	24	10	27	50
SSG-M24 (B/G/W)	M24x1.5	10-14	24	10	27	50
SSG-M25-X (B/G/W)	M25x1.5	10-16	25	11	33	50
SSG-M25 (B/G/W)	M25x1.5	13-18	25	11	33	50
SSG-M27-X (B/G/W)	M27x2.0	10-14	27	11	33	50
SSG-M27 (B/G/W)	M27x2.0	13-18	27	11	33	50
SSG-M30-X (B/G/W)	M30x2.0	10-14	30	11	33	50
SSG-M30 (B/G/W)	M30x2.0	13-18	30	11	33	50
SSG-M32-X (B/G/W)	M32x1.5	13-18	32	11	42	25
SSG-M32 (B/G/W)	M32x1.5	18-25	32	11	42	25
SSG-M33 (B/G/W)	M33x2.0	18-25	33	11	42	25
SSG-M36-X (B/G/W)	M36x2.0	13-18	36	11	42	25
SSG-M36 (B/G/W)	M36x2.0	18-25	36	11	42	25
SSG-M40 (B/G/W)	M40x1.5	22-32	40	13	52	10
SSG-M42 (B/G/W)	M42x2.0	22-32	42	13	52	10
SSG-M45 (B/G/W)	M45x2.0	22-32	45	13	52	10
SSG-M48 (B/G/W)	M48x2.0	22-32	48	13	52	10
SSG-M50 (B/G/W)	M50x1.5	32-38	50	15	60	10
SSG-M56 (B/G/W)	M56x2.0	32-38	56	15	60	10
SSG-M60 (B/G/W)	M60x2.0	37-44	60	14	65	5
SSG-M63 (B/G/W)	M63x1.5	37-44	63	14	65	5
SSG-M64 (B/G/W)	M64x2.0	37-44	64	14	65	5



## SSG系列

## 塑料电缆防水接头 Nylon Cable Gland

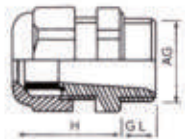

材料: PA6, 密封件材料: 丁腈橡胶  
 防护等级: 在规定的卡口范围内, 并使用合适的O形密封圈, 防护等级可以达到IP68  
 温度范围: 静态: -40°C到100°C, 短时间可以达到120°C  
 动态: -20°C到80°C, 短时间可以达到100°C  
 颜色: 黑色 (RAL9005) / 灰白色 (9018) / 深灰色 (7037)  
 Material: PA6, Sealing: NBR  
 Protection degree: Using suitable O-sealing within the clamping range,  
 The protection degree can reach IP68  
 Temperature Range: Stat.: Min-40°C, Max100°C, Short-term120°C  
 Dyn.: Min-20°C, Max80°C, Short-term100°C  
 Color: Black(RAL9005)/White Gray(RAL9018)/Dark Gary(RAL7037)

## SSG-M-L 加长型公制螺纹 Lengthened Metric Thread

订货编号 Article	螺纹规格 Thread	卡口范围 Clamping range	螺纹外径 AG	螺纹长度 GL	扳手尺寸 Wrench size	包装单位 Packet
注: 黑 (B) 灰 (G) 白 (W)	Dimension	mm	mm	mm	mm	units
SSG-M12-L (B/G/W)	M12x1.5	3-6.5	12	15	15	100
SSG-M16-XL (B/G/W)	M16x1.5	3-6.5	16	15	19	100
SSG-M16-L (B/G/W)	M16x1.5	4-8	16	15	19	100
SSG-M18-L (B/G/W)	M18x1.5	5-10	18	15	22	100
SSG-M20-XL (B/G/W)	M20x1.5	5-10	20	15	24	100
SSG-M20-L (B/G/W)	M20x1.5	6-12	20	15	24	100
SSG-M22-XL (B/G/W)	M22x1.5	6-12	22	15	27	50
SSG-M22-L (B/G/W)	M22x1.5	10-14	22	15	27	50
SSG-M24-XL (B/G/W)	M24x1.5	6-12	24	15	27	50
SSG-M24-L (B/G/W)	M24x1.5	10-14	24	15	27	50
SSG-M25-XL (B/G/W)	M25x1.5	10-16	25	15	33	50
SSG-M25-L (B/G/W)	M25x1.5	13-18	25	15	33	50
SSG-M27-L (B/G/W)	M27x2.0	13-18	27	15	33	50
SSG-M32-XL (B/G/W)	M32x1.5	13-18	32	15	42	25
SSG-M32-L (B/G/W)	M32x1.5	18-25	32	15	42	25
SSG-M36-L (B/G/W)	M36x2.0	18-25	36	15	42	25
SSG-M40-L (B/G/W)	M40x1.5	22-32	40	15	52	10

## SSG-N/G NPT/G制螺纹 NPT/G Thread

订货编号 Article	螺纹规格 Thread	卡口范围 Clamping range	螺纹外径 AG	螺纹长度 GL	扳手尺寸 Wrench size	包装单位 Packet
注: 黑 (B) 灰 (G) 白 (W)	Dimension	mm	mm	mm	mm	units
SSG-N3/8 (B/G/W)	NPT3/8"	4-8	17.055	11	22	100
SSG-N1/2 (B/G/W)	NPT1/2"	6-12	21.223	14	24	100
SSG-N3/4 (B/G/W)	NPT3/4"	13-18	26.568	14	33	50
SSG-N1 (B/G/W)	NPT1"	18-25	33.227	11	42	25
SSG-N1-1/4 (B/G/W)	NPT1-1/4"	22-32	41.988	13	52	10
SSG-N1-1/2 (B/G/W)	NPT1-1/2"	32-38	48.054	16	60	10
SSG-N2 (B/G/W)	NPT2"	37-44	60.092	16	65	5
SSG-G3/8 (B/G/W)	G3/8"	4-8	16.662	11	22	100
SSG-G1/2 (B/G/W)	G1/2"	6-12	20.995	14	24	100
SSG-G3/4 (B/G/W)	G3/4"	13-18	26.441	14	33	50
SSG-G1 (B/G/W)	G1"	18-25	33.249	11	42	25
SSG-G1-1/4 (B/G/W)	G1-1/4"	22-32	41.910	13	52	10
SSG-G1-1/2 (B/G/W)	G1-1/2"	32-38	47.803	16	60	10
SSG-G2 (B/G/W)	G2"	37-44	59.614	16	65	5

## SSG系列

## 塑料电缆防水接头 Nylon Cable Gland

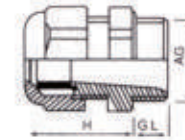

材料: PA6, 密封件材料: 丁腈橡胶  
 防护等级: 在规定的卡口范围内, 并使用合适的O形密封圈, 防护等级可以达到IP68  
 温度范围: 静态: -40°C到100°C, 短时间可以达到120°C  
 动态: -20°C到80°C, 短时间可以达到100°C  
 颜色: 黑色 (RAL9005) / 灰白色 (9018) / 深灰色 (7037)

Material: PA6, Sealing: NBR  
 Protection degree: Using suitable O-sealing within the clamping range,  
 The protection degree can reach IP68  
 Temperature Range: Stat.: Min-40°C, Max100°C, Short-term120°C  
 Dyn.: Min-20°C, Max80°C, Short-term100°C  
 Color: Black(RAL9005)/White Gray(RAL9018)/Dark Gary(RAL7037)

## SSG-PG 德制螺纹 PG Thread

订货编号 Article	螺纹规格 Thread	卡口范围 Clamping range	螺纹外径 AG	螺纹长度 GL	扳手尺寸 Wrench size	包装单位 Packet
注: 黑 (B) 灰 (G) 白 (W)	Dimension	mm	mm	mm	mm	units
SSG-P7 (B/G/W)	PG7	3-6.5	12.5	8.5	15	100
SSG-P9-X (B/G/W)	PG9	3-6.5	15.2	8.5	19	100
SSG-P9 (B/G/W)	PG9	4-8	15.2	8.5	19	100
SSG-P11 (B/G/W)	PG11	5-10	18.6	8	22	100
SSG-P13.5-X (B/G/W)	PG13.5	5-10	20.4	10	24	100
SSG-P13.5 (B/G/W)	PG13.5	6-12	20.4	10	24	100
SSG-P16-X (B/G/W)	PG16	6-12	22.5	10	27	50
SSG-P16 (B/G/W)	PG16	10-14	22.5	10	27	50
SSG-P21-X (B/G/W)	PG21	10-16	28.3	11	33	50
SSG-P21 (B/G/W)	PG21	13-18	28.3	11	33	50
SSG-P29-X (B/G/W)	PG29	13-18	37	11	42	25
SSG-P29 (B/G/W)	PG29	18-25	37	11	42	25
SSG-P36 (B/G/W)	PG36	22-32	47	13	52	10
SSG-P42 (B/G/W)	PG42	32-38	54	15	60	10
SSG-P48 (B/G/W)	PG48	37-44	59.3	14	65	5

## SSG-PG-L 加长型德制螺纹 Lengthened PG Thread

订货编号 Article	螺纹规格 Thread	卡口范围 Clamping range	螺纹外径 AG	螺纹长度 GL	扳手尺寸 Wrench size	包装单位 Packet
注: 黑 (B) 灰 (G) 白 (W)	Dimension	mm	mm	mm	mm	units
SSG-P7 (B/G/W)	PG7	3-6.5	12.5	15	15	100
SSG-P9-X (B/G/W)	PG9	3-6.5	15.2	15	19	100
SSG-P9 (B/G/W)	PG9	4-8	15.2	15	19	100
SSG-P11 (B/G/W)	PG11	5-10	18.6	15	22	100
SSG-P13.5-X (B/G/W)	PG13.5	5-10	20.4	15	24	100
SSG-P13.5 (B/G/W)	PG13.5	6-12	20.4	15	24	100
SSG-P16-X (B/G/W)	PG16	6-12	22.5	15	27	50
SSG-P16 (B/G/W)	PG16	10-14	22.5	15	27	50
SSG-P21-X (B/G/W)	PG21	10-16	28.3	15	33	50
SSG-P21 (B/G/W)	PG21	13-18	28.3	15	33	50
SSG-P29-X (B/G/W)	PG29	13-18	37	15	42	25
SSG-P29 (B/G/W)	PG29	18-25	37	15	42	25



## SSG系列

## 多孔塑料电缆接头 Nylon cable gland with Multi-holes

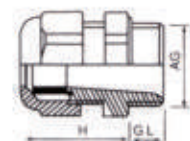

材料: PA6, 密封件材料: TPE热塑性弹性体  
 防护等级: 在规定的卡口范围内, 并使用合适的O形密封圈, 防护等级可以达到IP68  
 温度范围: 静态: -40°C到100°C, 短时间可以达到120°C  
 动态: -20°C到80°C, 短时间可以达到100°C  
 颜色: 黑色 (RAL9005) /灰白色 (9018) /深灰色 (7037)  
 Material: PA6, Sealing: TPE  
 Protection degree: Using suitable O-sealing within the clamping range,  
 The protection degree can reach IP68  
 Temperature Range: Stat.: Min-40°C, Max100°C, Short-term120°C  
 Dyn.: Min-20°C, Max80°C, Short-term100°C  
 Color :Black(RAL9005)/White Gray(RAL9018)/Dark Gary(RAL7037)

## SSG-M/nxd公制螺纹 Metric Thread

订货编号 Article	螺纹规格 Thread	孔数x 孔径 nxd	螺纹外径 AG	螺纹长度 GL	扳手尺寸 Wrench size	包装单位 Packet
注: 黑 (B) 灰 (G) 白 (W)	Dimension	mm	mm	mm	mm	units
SSG-M18/2X3(B/G/W)	M18X1.5	2X3	18	8	22	100
SSG-M20/2X5(B/G/W)	M20X1.5	2X5	20	10	24	100
SSG-M24/2X6(B/G/W)	M24X1.5	2X6	24	10	27	50
SSG-M24/7X3(B/G/W)	M24X1.5	7X3	24	10	27	50
SSG-M24/3X4(B/G/W)	M24X1.5	3X4	24	10	27	50
SSG-M24/9X2.6(B/G/W)	M24X1.5	9X2.6	24	10	27	50
SSG-M25/2X6(B/G/W)	M25X1.5	2X6	25	11	33	25
SSG-M25/4X6(B/G/W)	M25X1.5	4X6	25	11	33	25
SSG-M32/10X6(B/G/W)	M32X1.5	10X6	32	11	42	20
SSG-M32/3X12(B/G/W)	M32X1.5	3X12	32	11	42	20
SSG-M32/6X6(B/G/W)	M32X1.5	6X6	32	11	42	20
SSG-M32/4X4.2(B/G/W)	M32X1.5	4X4.2	32	11	42	20
SSG-M32/18X2.6(B/G/W)	M32X1.5	18X2.6	32	11	42	20
SSG-M32/6X5.8(B/G/W)	M32X1.5	6X5.8	32	11	42	20
SSG-M32/10X2.6(B/G/W)	M32X1.5	10X2.6	32	11	42	20
SSG-M32/18X3.5(B/G/W)	M32X1.5	18X3.5	32	11	42	20
SSG-M32/5X5.1(B/G/W)	M32X1.5	5X5.1	32	11	42	20
SSG-M32/25X3.5(B/G/W)	M32X1.5	25X3.5	32	11	42	20
SSG-M40/2X15(B/G/W)	M40X1.5	2X15	40	13	52	10
SSG-M40/9X7(B/G/W)	M40X1.5	9X7	40	13	52	10
SSG-M40/10X5(B/G/W)	M40X1.5	10X5	40	13	52	10
SSG-M40/45X2.6(B/G/W)	M40X1.5	45X2.6	40	13	52	10
SSG-M40/8X7.5(B/G/W)	M40X1.5	8X7.5	40	13	52	10
SSG-M40/32X3.5(B/G/W)	M40X1.5	32X3.5	40	13	52	10
SSG-M40/20X2.5(B/G/W)	M40X1.5	20X2.5	40	13	52	10
SSG-M40/55X2.6(B/G/W)	M40X1.5	55X2.6	40	13	52	10
SSG-M50/4X13(B/G/W)	M50X1.5	4X13	50	15	60	10
SSG-M63/5X12(B/G/W)	M63X1.5	5X12	63	15	65	5

## SSG系列

## 多孔塑料电缆接头 Nylon cable gland with Multi-holes

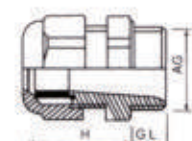

材料: PA6, 密封件材料: TPE热塑性弹性体  
 防护等级: 在规定的卡口范围内, 并使用合适的O形密封圈, 防护等级可以达到IP68  
 温度范围: 静态: -40°C到100°C, 短时间可以达到120°C  
 动态: -20°C到80°C, 短时间可以达到100°C  
 颜色: 黑色 (RAL9005) /灰白色 (9018) /深灰色 (7037)  
 Material: PA6, Sealing: TPE  
 Protection degree: Using suitable O-sealing within the clamping range,  
 The protection degree can reach IP68  
 Temperature Range: Stat.: Min-40°C, Max100°C, Short-term120°C  
 Dyn.: Min-20°C, Max80°C, Short-term100°C  
 Color :Black(RAL9005)/White Gray(RAL9018)/Dark Gary(RAL7037)

## SSG-P/nxd德制螺纹 PG Thread

订货编号 Article	螺纹规格 Thread	孔数x 孔径 nxd	螺纹外径 AG	螺纹长度 GL	扳手尺寸 Wrench size	包装单位 Packet
注: 黑 (B) 灰 (G) 白 (W)	Dimension	mm	mm	mm	mm	units
SSG-P11/2X3(B/G/W)	PG11	2X3	18.6	8	22	100
SSG-P13/2X5(B/G/W)	PG13.5	2X5	20.4	9	24	100
SSG-P16/2X6(B/G/W)	PG16	2X6	22.5	10	27	50
SSG-P16/7X3(B/G/W)	PG16	7X3	22.5	10	27	50
SSG-P16/3X4(B/G/W)	PG16	3X4	22.5	10	27	50
SSG-P16/9X2.6(B/G/W)	PG16	9X2.6	22.5	10	27	50
SSG-P21/2X6(B/G/W)	PG21	2X6	28.3	11	33	25
SSG-P21/4X6(B/G/W)	PG21	4X6	28.3	11	33	25
SSG-P29/10X6(B/G/W)	PG29	10X6	37	11	42	20
SSG-P29/3X12(B/G/W)	PG29	3X12	37	11	42	20
SSG-P29/6X6(B/G/W)	PG29	6X6	37	11	42	20
SSG-P29/4X4.2(B/G/W)	PG29	4X4.2	37	11	42	20
SSG-P29/18X2.6(B/G/W)	PG29	18X2.6	37	11	42	20
SSG-P29/6X5.8(B/G/W)	PG29	6X5.8	37	11	42	20
SSG-P29/10X2.6(B/G/W)	PG29	10X2.6	37	11	42	20
SSG-P29/18X3.5(B/G/W)	PG29	18X3.5	37	11	42	20
SSG-P29/5X5.1(B/G/W)	PG29	5X5.1	37	11	42	20
SSG-P29/25X3.5(B/G/W)	PG29	25X3.5	37	11	42	20
SSG-P36/2X15(B/G/W)	PG36	2X15	47	13	52	10
SSG-P36/9X7(B/G/W)	PG36	9X7	47	13	52	10
SSG-P36/10X5(B/G/W)	PG36	10X5	47	13	52	10
SSG-P36/45X2.6(B/G/W)	PG36	45X2.6	47	13	52	10
SSG-P36/8X7.5(B/G/W)	PG36	8X7.5	47	13	52	10
SSG-P36/32X3.5(B/G/W)	PG36	32X3.5	47	13	52	10
SSG-P36/20X2.5(B/G/W)	PG36	20X2.5	47	13	52	10
SSG-P36/55X2.6(B/G/W)	PG36	55X2.6	47	13	52	10
SSG-P42/4X13(B/G/W)	PG42	4X13	54	14	60	10
SSG-P48/5X12(B/G/W)	PG48	5X12	59.3	15	65	5



## SSFZ系列

## SSFZ塑料线缆防折接头 Anti-fold Nylon Cable Gland

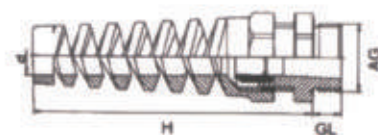

材料: PA6, 密封件材料: 丁晴橡胶  
 防护等级: 在规定的卡口范围内, 并使用合适的O形密封圈, 防护等级可以达到IP68  
 温度范围: 静态: -40°C到100°C, 短时间可以达到120°C  
 动态: -20°C到80°C, 短时间可以达到100°C  
 颜色: 黑色 (RAL9005) / 灰白色 (9018) / 深灰色 (7037)  
 Material: PA6, Sealing: NBR  
 Protection degree: Using suitable O-sealing within the clamping range,  
 The protection degree can reach IP68  
 Temperature Range: Stat.: Min-40°C, Max100°C, Short-term120°C  
 Dyn.: Min-20°C, Max80°C, Short-term100°C  
 Color :Black(RAL9005)/White Gray(RAL9018)/Dark Gary(RAL7037)

## SSFZ-M 公制螺纹 Metric Thread

订货编号 Article	螺纹规格 Thread	卡口范围 Clamping range	螺纹外径 AG	螺纹长度 GL	扳手尺寸 Wrench size	总长 Total length	包装单位 Packet
注: 黑 (B) 灰 (G) 白 (W)	Dimension	mm	mm	mm	mm	mm	units
SSFZ-M12(B/G/W)	M12x1.5	3-6.5	12	8	15	54	100
SSFZ-M16(B/G/W)	M16x1.5	4-8	16	8.5	19	63	100
SSFZ-M18(B/G/W)	M18x1.5	5-10	18	8	22	78	50
SSFZ-M20(B/G/W)	M20x1.5	6-12	20	10	24	90	50
SSFZ-M20-D(B/G/W)	M20x1.5	10-14	20	10	27	100	25
SSFZ-M25(B/G/W)	M25x1.5	13-18	25	11	33	114	25

## SSFZ-P 德制螺纹 PG Thread

订货编号 Article	螺纹规格 Thread	卡口范围 Clamping range	螺纹外径 AG	螺纹长度 GL	扳手尺寸 Wrench size	总长 Total length	包装单位 Packet
注: 黑 (B) 灰 (G) 白 (W)	Dimension	mm	mm	mm	mm	mm	units
SSFZ-P7(B/G/W)	PG7	3-6.5	12.5	8.5	15	54	100
SSFZ-P9(B/G/W)	PG9	4-8	15.2	8	19	63	100
SSFZ-P11(B/G/W)	PG11	5-10	18.6	8	22	78	50
SSFZ-P13(B/G/W)	PG13.5	6-12	20.4	10	24	90	50
SSFZ-P16(B/G/W)	PG16	10-14	22.5	10	27	100	25
SSFZ-P21(B/G/W)	PG21	13-18	28.3	11	33	114	25



## SSP系列

## 塑料闷盖 Nylon Screw Plug

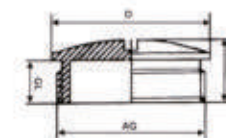

材料: PA6  
 防护等级: 在规定的卡口范围内, 并使用合适的O形密封圈, 防护等级可以达到IP68  
 温度范围: 静态: -40°C到100°C, 短时间可以达到120°C  
 颜色: 黑色 (RAL9005) / 灰白色 (9018)  
 Material: PA6  
 Protection degree: Using suitable O-sealing within the clamping range,  
 The protection degree can reach IP68  
 Temperature Range: Stat.: Min-40°C, Max100°C, Short-term120°C  
 Color :Black(RAL9005)/White Gray(RAL9018)

## SSP-M 公制螺纹 Metric Thread

订货编号 Article	螺纹规格 Thread	螺纹外径 AG	螺纹长度 GL	闷盖外径 D	包装单位 Packet
注: 黑 (B) 白 (W)	Dimension	mm	mm	mm	units
SSP-M10(B/W)	M10x1.0	10	6.5	15	100
SSP-M12(B/W)	M12x1.5	12	7	15	100
SSP-M16(B/W)	M16x1.5	16	7	19	100
SSP-M18(B/W)	M18x1.5	18	8	22	100
SSP-M20(B/W)	M20x1.5	20	8	25	100
SSP-M22(B/W)	M22x1.5	22	8	27	100
SSP-M24(B/W)	M24x1.5	24	8	29	100
SSP-M25(B/W)	M25x1.5	25	8	30	100
SSP-M27(B/W)	M27x2.0	27	8	33	100
SSP-M30(B/W)	M30x2.0	30	8	35	50
SSP-M32(B/W)	M32x1.5	32	9	39	50
SSP-M36(B/W)	M36x2.0	36	9	44	50
SSP-M40(B/W)	M40x1.5	40	11	48	25
SSP-M48(B/W)	M48x2.0	48	11	55	25
SSP-M50(B/W)	M50x1.5	50	12	62	25
SSP-M63(B/W)	M63x1.5	63	12	70	25

## SSP-P 德制螺纹 PG Thread

订货编号 Article	螺纹规格 Thread	螺纹外径 AG	螺纹长度 GL	闷盖外径 D	包装单位 Packet
注: 黑 (B) 白 (W)	Dimension	mm	mm	mm	units
SSP-P7(B/W)	PG7	12.5	7	15	100
SSP-P9(B/W)	PG9	15.2	7	20	100
SSP-P11(B/W)	PG11	18.6	8	22	100
SSP-P13(B/W)	PG13.5	20.4	8	25	100
SSP-P16(B/W)	PG16	22.5	8	27	100
SSP-P21(B/W)	PG21	28.3	8	33	100
SSP-P29(B/W)	PG29	37	9	39	50
SSP-P36(B/W)	PG36	47	11	46	25
SSP-P42(B/W)	PG42	54	12	57	25
SSP-P48(B/W)	PG48	59.3	13	70	25



## SSR系列

### 塑料减缩环 Nylon reducer



外型A (Form A)

外型B (Form B)

材料: PA6  
 防护等级: 在规定的卡口范围内, 并使用合适的O形密封圈, 防护等级可以达到IP68  
 温度范围: 静态: -40°C到100°C, 短时间可以达到120°C  
 颜色: 黑色 (RAL9005) /灰白色 (9018)  
 Material: PA6  
 Protection degree: Using suitable O-sealing within the clamping range,  
 The protection degree can reach IP68  
 Temperature Range: Stat.: Min -40°C, Max 100°C, Short-term 120°C  
 Color: Black (RAL9005)/White Gray (RAL9018)

订货编号 Article	外螺纹规格 Outer Thread	内螺纹规格 Inner Thread	外螺纹长度 Thread Length	总长 Total Length	扳手尺寸 Wrench	外型A/B Form A/B	包装单位 Packing
注: 黑 (B) 白 (W)							
SSR-P11/P9(B/W)	PG11	PG9	9	15	24	A	100
SSR-P13/P9(B/W)	PG13.5	PG9	9	15	24	A	100
SSR-P13/P11(B/W)	PG13.5	PG11	8	22	22	B	100
SSR-P16/P11(B/W)	PG16	PG11	10	27	27	B	50
SSR-P16/P13(B/W)	PG16	PG13.5	10	27	27	B	50
SSR-P16/P16(B/W)	PG16	PG16	10	27	27	B	50
SSR-P16/M16(B/W)	PG16	M16X1.5	9	15	27	B	50
SSR-P21/P16(B/W)	PG21	PG16	11	17	39	A	50
SSR-P29/P21(B/W)	PG29	PG21	11	17	39	A	50
SSR-M20/P9(B/W)	M20X1.5	PG9	9	15	23.5	A	100
SSR-M20/P11(B/W)	M20X1.5	PG11	8	22	22	B	100
SSR-M20/M12(B/W)	M20X1.5	M12X1.5	9	15	24	A	100
SSR-M20/M16(B/W)	M20X1.5	M16X1.5	9	15	24	A	100
SSR-M25/M20(B/W)	M25X1.5	M20X1.5	9.5	26	30	B	50
SSR-M27/M16(B/W)	M27X2.0	M16X1.5	9	15	30	A	50
SSR-M30/M16(B/W)	M30X2.0	M16X1.5	14.5	24.5	35	A	50
SSR-M32/M20(B/W)	M32X1.5	M20X1.5	11.5	17	39	A	50
SSR-M32/M25(B/W)	M32X1.5	M25X1.5	11.5	17	39	A	50
SSR-M36/M25(B/W)	M36X2.0	M32X1.5	11.5	17.5	39	A	50
SSR-M40/M25(B/W)	M40X1.5	M25X1.5	11	17	45	A	50
SSR-M40/M32(B/W)	M40X1.5	M32X1.5	11	17	45	A	50

## SSE系列

### 塑料增扩环 Nylon Enlarger

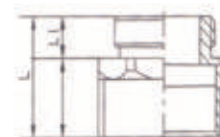

材料: PA6  
 防护等级: 在规定的卡口范围内, 并使用合适的O形密封圈, 防护等级可以达到IP68  
 温度范围: 静态: -40°C到100°C, 短时间可以达到120°C  
 颜色: 黑色 (RAL9005) /灰白色 (9018)  
 Material: PA6  
 Protection degree: Using suitable O-sealing within the clamping range,  
 The protection degree can reach IP68  
 Temperature Range: Stat.: Min -40°C, Max 100°C, Short-term 120°C  
 Color: Black (RAL9005)/White Gray (RAL9018)/

订货编号 Article	外螺纹规格 Outer Thread	内螺纹规格 Inner Thread	外螺纹长度 Thread Length	总长 Total Length	扳手尺寸 Wrench	包装单位 Packing
注: 黑 (B) 白 (W)						
SSE-P9/P11(B/W)	PG9	PG11	10	24	22	100
SSE-P9/P16(B/W)	PG9	PG16	10	27	27	100
SSE-P11/M20(B/W)	PG11	M20X1.5	8	25	27	100
SSE-P13/P16(B/W)	PG13.5	PG16	8	25	27	100
SSE-P16/P21(B/W)	PG16	PG21	10	27	30	100
SSE-M16/M20(B/W)	M16X1.5	M20X1.5	10	27	27	100
SSE-M16/P16(B/W)	M16X1.5	PG16	10	27	27	100
SSE-M16/M25(B/W)	M16X1.5	M25X1.5	10	27	30	50
SSE-M16/M27(B/W)	M16X1.5	M27X2.0	10	27	30	50
SSE-M20/M25(B/W)	M20X1.5	M25X1.5	8	25	30	50
SSE-M32/M40(B/W)	M32X1.5	M40X1.5	14.5	34	44.5	50
SSE-M40/M50(B/W)	M40X1.5	M50X1.5	14	37	55	25



# SSN系列

## 塑料螺母 Nylon Locknuts



材料: PA6  
 温度范围: 静态: -40°C到100°C, 短时间可以达到120°C  
 颜色: 黑色 (RAL9005) /灰白色 (9018) /深灰色 (7037)  
 Material: PA6  
 Temperature Range: Stat.: Min -40°C, Max 100°C, Short-term 120°C  
 Color: Black (RAL9005) / White Gray (RAL9018) / Dark Gary (RAL7037)

### SSP-M 公制螺纹 Metric Thread

订货编号 Article	螺纹规格 Thread	扳手尺寸 Wrench	厚度 Thickness	包装单位 Packet
注: 黑 (B) 白 (W)	Dimension	mm	mm	units
SSN-M10(B/G/W)	M10x1.0	19	5	100
SSN-M12(B/G/W)	M12x1.5	19	5	100
SSN-M16(B/G/W)	M16x1.5	22	5	100
SSN-M18(B/G/W)	M18x1.5	24	5	100
SSN-M20(B/G/W)	M20x1.5	27	6	100
SSN-M22(B/G/W)	M22x1.5	30	6	100
SSN-M24(B/G/W)	M24x1.5	30	6	100
SSN-M25(B/G/W)	M25x1.5	32	6	100
SSN-M27(B/G/W)	M27x2.0	36	7	100
SSN-M30(B/G/W)	M30x2.0	36	7	100
SSN-M32(B/G/W)	M32x1.5	40	7	100
SSN-M33(B/G/W)	M33x2.0	40	7	100
SSN-M36(B/G/W)	M36x2.0	45	7	100
SSN-M40(B/G/W)	M40x1.5	49	8	50
SSN-M42(B/G/W)	M42x2.0	53	8	50
SSN-M48(B/G/W)	M48x2.0	60	8	50
SSN-M50(B/G/W)	M50x1.5	60	8	50
SSN-M56(B/G/W)	M56x2.0	65	8	50
SSN-M63(B/G/W)	M63x1.5	75	8	25
SSN-M64(B/G/W)	M64x2.0	75	8	25

### SSP-P 德制螺纹 PG Thread

订货编号 Article	螺纹规格 Thread	扳手尺寸 Wrench	厚度 Thickness	包装单位 Packet
注: 黑 (B) 白 (W)	Dimension	mm	mm	units
SSN-P7(B/G/W)	PG7	19	5	100
SSN-P9(B/G/W)	PG9	22	5	100
SSN-P11(B/G/W)	PG11	24	5	100
SSN-P13(B/G/W)	PG13.5	27	6	100
SSN-P16(B/G/W)	PG16	30	6	100
SSN-P21(B/G/W)	PG21	36	7	500
SSN-P29(B/G/W)	PG29	45	7	500
SSN-P36(B/G/W)	PG36	60	8	50
SSN-P42(B/G/W)	PG42	65	8	50
SSN-P48(B/G/W)	PG48	70	8	25



### 电缆防水接头系列 Cable Gland Series

塑料篇 Plastic

▶ 金属篇 Metal

塑料波纹软管及接头系列 Plastic Flexible Conduit & Fitting

软管接头及配件 Fitting & Accessory

金属软管及接头 Metal Flexible Conduit & Fitting

塑料工程拖链 Plastic Cable Drag Chain

散热防水透气阀 Breathable Vent Plug

塑料冷却水管 Cooling Tube



## SSMG系列

### 金属电缆防水接头Metal Cable Gland

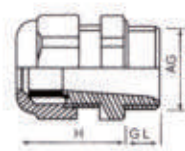

材料: 外部金属为黄铜镀镍; 内部塑料芯套为尼龙, 密封件为丁腈橡胶。  
 防护等级: 在规定的卡口范围内, 并使用合适的O型密封圈, 防护等级可以达到IP68。  
 温度范围: 静态: -40°C-100°C, 短时间可达120°C  
 动态: -20°C-80°C, 短时间可达100°C  
 Material: Body: Nickel Plated brass. Inner parts: Nylon 6; Sealing: NBR  
 Protection degree: Using suitable O-sealing within the clamping range, The protection degree can reach IP68  
 Temperature Range: Stat.: Min-40°C, Max100°C, Short-term120°C  
 Dyn.: Min-20°C, Max80°C, Short-term100°C

### SSMG-M 公制螺纹 Metric Thread

订货编号 Article No.	螺纹规格 Thread	卡口范围 Clamping range	外径尺寸 AG	螺纹长度 GL	扳手尺寸 Wrench size	包装单位 Packet
SSMG	Dimension	mm	mm	mm	mm	units
SSMG-M8	M8x1.25	3-4.5	8	5.5	11	100
SSMG-M10	M10x1.0	3-6.5	10	6	14	100
SSMG-M12	M12x1.5	3-6.5	12	6	14	100
SSMG-M14	M14x1.5	3-6.5	14	6	16	100
SSMG-M16	M16x1.5	4-8	16	7	18	100
SSMG-M16D	M16x1.5	5-10	16	7	20	100
SSMG-M18	M18x1.5	5-10	18	7	22	100
SSMG-M20X	M20x1.5	5-10	20	7	22	100
SSMG-M20	M20x1.5	6-12	20	8	22	100
SSMG-M20D	M20x1.5	10-14	20	7	24	50
SSMG-M22	M22x1.5	10-14	22	8	24	50
SSMG-M24	M24x1.5	10-14	24	8	27	50
SSMG-M25X	M25x1.5	10-14	25	8	27	50
SSMG-M25	M25x1.5	10-16	25	8	28	50
SSMG-M25D	M25x1.5	13-18	25	8	30	25
SSMG-M27X	M27x2.0	10-16	27	8	28	25
SSMG-M27	M27x2.0	13-18	27	8	30	25
SSMG-M30X	M30x2.0	10-16	30	8	30	25
SSMG-M30	M30x2.0	13-18	30	8	34	20
SSMG-M30D	M30x2.0	15-22	30	8	34	20
SSMG-M32X	M32x1.5	13-18	32	8	34	20
SSMG-M32	M32x1.5	15-22	32	9	34	20
SSMG-M32D	M32x1.5	18-25	32	9	40	20
SSMG-M33	M32x2.0	15-22	33	9	36	20
SSMG-M36	M36x2.0	15-22	36	9	40	20
SSMG-M36D	M36x2.0	18-25	36	9	40	20
SSMG-M40	M40x1.5	22-28	40	10	43	10
SSMG-M40D	M40x1.5	22-32	40	10	50	10
SSMG-M42	M42x2.0	22-28	42	10	45	10
SSMG-M48	M48x2.0	22-32	48	10	52	10
SSMG-M50	M50x1.5	25-32	50	10	55	5
SSMG-M50D	M50x1.5	32-38	50	12	58	5
SSMG-M56	M56x2.0	32-38	56	12	58	5
SSMG-M60	M60x2.0	37-44	60	12	64	5
SSMG-M63	M63x1.5	37-44	63	12	68	5
SSMG-M63D	M63x1.5	42-52	63	15	78	5
SSMG-M64	M64x2.0	37-44	64	12	68	5
SSMG-M72	M72x2.0	42-52	72	15	78	5
SSMG-M75	M75x2.0	42-52	75	15	78	5
SSMG-M80	M80x2.0	52-62	80	16	88	2
SSMG-M88	M88x2.0	65-70	88	16	88	2
SSMG-M100	M100x2.0	70-80	100	20	110	2

## SSMG系列

### 金属电缆防水接头Metal Cable Gland

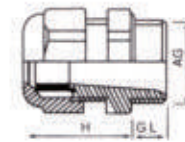

材料: 外部金属为黄铜镀镍; 内部塑料芯套为尼龙, 密封件为丁腈橡胶。  
 防护等级: 在规定的卡口范围内, 并使用合适的O型密封圈, 防护等级可以达到IP68。  
 温度范围: 静态: -40°C-100°C, 短时间可达120°C  
 动态: -20°C-80°C, 短时间可达100°C  
 Material: Body: Nickel Plated brass. Inner parts: Nylon 6; Sealing: NBR  
 Protection degree: Using suitable O-sealing within the clamping range, The protection degree can reach IP68  
 Temperature Range: Stat.: Min-40°C, Max100°C, Short-term120°C  
 Dyn.: Min-20°C, Max80°C, Short-term100°C

### SSMG-P 德制螺纹 PG Thread

订货编号 Article No.	螺纹规格 Thread	卡口范围 Clamping range	外径尺寸 AG	螺纹长度 GL	扳手尺寸 Wrench size	包装单位 Packet
SSMG	Dimension	mm	mm	mm	mm	units
SSMG-P7	PG7	3-6.5	12.5	6	14	100
SSMG-P9	PG9	4-8	15.2	7	17	100
SSMG-P11	PG11	5-10	18.6	7	20	100
SSMG-P13	PG13.5	6-12	20.4	8	22	100
SSMG-P16	PG16	10-14	22.5	8	24	50
SSMG-P21	PG21	13-18	28.3	8	30	25
SSMG-P29	PG29	18-25	37	9	40	20
SSMG-P36	PG36	22-32	47	10	50	10
SSMG-P42	PG42	32-38	54	10	58	5
SSMG-P48	PG48	37-44	59.3	12	68	5

### SSMG-G/NPT 管螺纹和美制螺纹 G/NPT Thread

订货编号 Article No.	螺纹规格 Thread	卡口范围 Clamping range	外径尺寸 AG	螺纹长度 GL	扳手尺寸 Wrench size	包装单位 Packet
SSMG	Dimension	mm	mm	mm	mm	units
SSMG-G1/4	G1/4"	3-6.5	13.157	6	14	100
SSMG-G3/8	G3/8"	4-8	16.662	7	17	100
SSMG-G1/2	G1/2"	6-12	20.995	8	22	100
SSMG-G3/4	G3/4"	10-14	26.441	8	24	50
SSMG-G1	G1"	18-25	33.249	9	40	20
SSMG-G1-1/4	G1-1/4"	22-32	41.910	10	50	10
SSMG-G1-1/2	G1-1/2"	32-38	47.803	10	58	5
SSMG-G2	G2"	37-44	59.614	12	68	5
SSMG-N1/4	NPT1/4"	3-6.5	13.616	6	14	100
SSMG-N3/8	NPT3/8"	4-8	17.055	7	17	100
SSMG-N1/2	NPT1/2"	6-12	21.223	8	22	100
SSMG-N3/4	NPT3/4"	10-14	26.568	8	24	50
SSMG-N1	NPT1"	18-25	33.228	9	40	20
SSMG-N1-1/4	NPT1-1/4"	22-32	41.988	10	50	10
SSMG-N1-1/2	NPT1-1/2"	32-38	48.054	10	58	5
SSMG-N2	NPT2"	37-44	60.092	12	68	5



## SSME系列

## 电磁兼容金属电缆防水接头F型 EMC Metal Cable Gland F type



材质: 外部采用优质黄铜镀镍, 内部塑料部分为尼龙, 密封圈为丁腈橡胶, 爪子为不锈钢片。  
防护等级: 在规定的卡口范围内, 并使用O形密封圈旋紧迫紧头, 可达IP68。

温度范围: 静态: -40°C-100°C, 短时间可以达到120°C  
动态: -20°C-80°C, 短时间可以达到100°C

Material: The body: Brass plated nickel Seal: Nylon, Sealing: NBR  
Protection: Using suitable Sealing within the clamping range, can reach to IP68.  
Temperature Range: Stat: Min -40°C-100°C, short time to 120°C  
Dyn: Min -20°C-80°C, short time to 100°C

使用方法: 将屏蔽电缆的外护层破除一小段, 并将屏蔽层截断, 将一小段屏蔽层导体反包在接头的内芯套外部, 长度应长于密封圈位置, 然后用力放入电缆接头, 并旋紧。

Method of use: Break the outer sheath of the shielded cable a short time, cut off the shield, turn over a small section of the shield conductor over the inner core sleeve of the joint, the length should be longer than the seal ring position, and then forcefully put into the cable joint, And tighten it.

可定制不同长度螺纹 Different length thread can be customized

## SSME-F-M 公制螺纹

订货编号	螺纹规格	卡口范围	螺纹外径	螺纹长度	扳手尺寸
Article No.	Thread	Clamping range	AG	GL	Wrench size
	Dimension	mm	mm	mm	mm
SSME-F-M12	M12x1.5	4-8	12	5	20
SSME-F-M16	M16x1.5	5-10	16	6	22
SSME-F-M20	M20x1.5	10-14	20	7	26
SSME-F-M25	M25x1.5	13-18	25	7	30
SSME-F-M32	M32x1.5	16-24	32	8	32
SSME-F-M40	M40x1.5	22-32	40	9	50
SSME-F-M50	M50x1.5	30-40	50	9	60
SSME-F-M63	M63x1.5	38-53	63	10	75
SSME-F-M75	M75x1.5	38-53	63	10	75

## SSME-F-PG 德制螺纹

订货编号	螺纹规格	卡口范围	螺纹外径	螺纹长度	扳手尺寸
Article No.	Thread	Clamping range	AG	GL	Wrench size
	Dimension	mm	mm	mm	mm
SSME-F-P7	PG7	4-8	12.5	5	20
SSME-F-P9	PG9	5-10	15.2	6	22
SSME-F-P11	PG11	5-10	18.6	6	22
SSME-F-P13	PG13.5	10-14	20.4	7	26
SSME-F-P16	PG16	10-14	22.5	7	26
SSME-F-P21	PG21	13-18	28.3	7	30
SSME-F-P29	PG29	16-24	37	8	40
SSME-F-P36	PG36	22-32	47	9	50
SSME-F-P42	PG42	30-40	54	9	60
SSME-F-P48	PG48	38-53	59.3	10	7

## SSME系列

## 电磁兼容金属电缆防水接头经济型T型 EMC Metal Cable Gland Economic type T



材质: 外部采用优质黄铜镀镍, 内部塑料部分为尼龙, 密封圈为丁腈橡胶, 爪子为不锈钢片。  
防护等级: 在规定的卡口范围内, 并使用O形密封圈旋紧迫紧头, 可达IP68。

温度范围: 静态: -40°C-100°C, 短时间可以达到120°C  
动态: -20°C-80°C, 短时间可以达到100°C

Material: The body: Brass plated nickel Seal: Nylon, Sealing: NBR  
Protection: Using suitable Sealing within the clamping range, can reach to IP68.  
Temperature Range: Stat: Min -40°C-100°C, short time to 120°C  
Dyn: Min -20°C-80°C, short time to 100°C

使用方法: 将屏蔽电缆的外护层破除一小段, 并将屏蔽层截断, 将一小段屏蔽层导体反包在接头的内芯套外部, 长度应长于密封圈位置, 然后用力放入电缆接头, 并旋紧。

Method of use: Break the outer sheath of the shielded cable a short time, cut off the shield, turn over a small section of the shield conductor over the inner core sleeve of the joint, the length should be longer than the seal ring position, and then forcefully put into the cable joint, And tighten it.

## SSME-T-M 公制螺纹

订货编号	螺纹规格	卡口范围	螺纹外径	螺纹长度	扳手尺寸
Article No.	Thread	Clamping range	AG	GL	Wrench size
	Dimension	mm	mm	mm	mm
SSME-T-M12	M12x1.5	4-8	12	7	17
SSME-T-M16	M16x1.5	4-8	16	7	18
SSME-T-M16D	M16x1.5	5-10	16	7	20
SSME-T-M18	M18x1.5	5-10	18	7	20
SSME-T-M20X	M20x1.5	5-10	20	7	22
SSME-T-M20	M20x1.5	6-12	20	8	22
SSME-T-M20D	M20x1.5	10-14	20	8	24
SSME-T-M22	M22x1.5	10-14	22	8	24
SSME-T-M24	M24x1.5	10-14	24	8	27
SSME-T-M25	M25x1.5	10-14	25	8	27
SSME-T-M25	M25x1.5	10-16	25	8	28
SSME-T-M25	M25x1.5	13-18	25	8	30
SSME-T-M27	M27x2.0	13-18	27	8	30
SSME-T-M30	M30x2.0	13-18	30	8	34
SSME-T-M32	M32x1.5	15-22	32	8	34
SSME-T-M32D	M32x1.5	18-25	32	9	40
SSME-T-M36	M36x1.5	18-25	36	9	40
SSME-T-M40	M40x1.5	22-28	40	10	43
SSME-T-M40	M40x1.5	22-32	40	10	50
SSME-T-M50	M50x1.5	32-38	50	12	58
SSME-T-M63	M63x1.5	37-44	63	12	68
SSME-T-M64	M64x2.0	37-44	64	12	68

## SSME-T-PG 德制螺纹

订货编号	螺纹规格	卡口范围	螺纹外径	螺纹长度	扳手尺寸
Article No.	Thread	Clamping range	AG	GL	Wrench size
	Dimension	mm	mm	mm	mm
SSME-T-P7	PG7	4-8	12.5	7	207
SSME-T-P9	PG9	4-8	15.2	7	17
SSME-T-P11	PG11	5-10	18.6	7	20
SSME-T-P13	PG13.5	6-12	20.4	8	22
SSME-T-P16	PG16	10-14	22.5	8	24
SSME-T-P21	PG21	13-18	28.3	8	30
SSME-T-P29	PG29	18-25	37	9	40
SSME-T-P36	PG36	22-32	47	10	50
SSME-T-P42	PG42	32-38	54	10	58
SSME-T-P48	PG48	37-44	59.3	12	64



## SSMG-nxd系列

### 多孔金属电缆防水接头Cable Gland with Multi-apertured

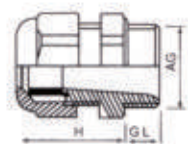

材质: 外部为黄铜镀镍, 内部塑料件为尼龙6  
密封件材质: TPE/TPV 弹性体  
Material: Body: Brass plate nickel, Inner part is nylon6  
sealing: TPE or TPV.



#### SSMG-M/nxd公制螺纹 Metric Thread

订货编号 Article No.	螺纹规格 Thread Dimension	孔数x 孔径 nxd mm	外径尺寸 AG mm	螺纹长度 GL mm	扳手尺寸 Wrench size mm	包装单位 Packet units
SSMG-M18/2X3	M18X1.5	2X3	18	7	20	100
SSMG-M20/2X5	M20X1.5	2X5	20	8	22	100
SSMG-M24/2X6	M24X1.5	2X6	24	8	27	50
SSMG-M24/7X3	M24X1.5	7X3	24	8	27	50
SSMG-M24/3X4	M24X1.5	3X4	24	8	27	50
SSMG-M24/9X2.6	M24X1.5	9X2.6	24	8	27	50
SSMG-M25/2X6	M25X1.5	2X6	25	8	30	25
SSMG-M25/4X6	M25X1.5	4X6	25	8	30	25
SSMG-M32/10X6	M32X1.5	10X6	32	9	40	20
SSMG-M32/3X12	M32X1.5	3X10	32	9	40	20
SSMG-M32/6X6	M32X1.5	6X6	32	9	40	20
SSMG-M32/4X4.2	M32X1.5	4X4.2	32	9	40	20
SSMG-M32/18X2.6	M32X1.5	18X2.6	32	9	40	20
SSMG-M32/6X5.8	M32X1.5	6X5.8	32	9	40	20
SSMG-M32/10X2.6	M32X1.5	10X2.6	32	9	40	20
SSMG-M32/18X3.5	M32X1.5	18X3.5	32	9	40	20
SSMG-M32/5X5.1	M32X1.5	5X5.1	32	9	40	20
SSMG-M32/25X3.5	M32X1.5	25X3.5	32	9	40	20
SSMG-M40/2X5	M40X1.5	2X5	40	10	50	10
SSMG-M40/9X7	M40X1.5	9X7	40	10	50	10
SSMG-M40/10X5	M40X1.5	10X5	40	10	50	10
SSMG-M40/45X2.6	M40X1.5	45X2.6	40	10	50	10
SSMG-M40/8X7.5	M40X1.5	8X7.5	40	10	50	10
SSMG-M40/32X3.5	M40X1.5	32X3.5	40	10	50	10
SSMG-M40/20X2.5	M40X1.5	20X2.5	40	10	50	10
SSMG-M40/55X2.6	M40X1.5	55X2.6	40	10	50	10
SSMG-M50/4X13	M50X1.5	4X13	50	12	58	5
SSMG-M63/5X12	M63X1.5	5X12	63	12	68	5

## SSMG-nxd系列

### 多孔金属电缆防水接头Cable Gland with Multi-apertured

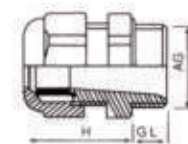

材质: 外部为黄铜镀镍, 内部塑料件为尼龙6  
密封件材质: TPE/TPV 弹性体  
Material: Body: Brass plate nickel, Inner part is nylon6  
sealing: TPE or TPV.



#### SSMG-PG/nxd公制螺纹 PG Thread

订货编号 Article No.	螺纹规格 Thread Dimension	孔数x 孔径 nxd mm	外径尺寸 AG mm	螺纹长度 GL mm	扳手尺寸 Wrench size mm	包装单位 Packet units
SSMG-P11/2X3	PG11	2X3	18.6	8	22	100
SSMG-P13./2X5	PG13.5	2X5	20.4	9	24	100
SSMG-P16/2X6	PG16	2X6	22.5	10	27	50
SSMG-P16/7X3	PG16	7X3	22.5	10	27	50
SSMG-P16/3X4	PG16	3X4	22.5	10	27	50
SSMG-P16/9X2.6	PG16	9X2.6	22.5	10	27	50
SSMG-P21/2X6	PG21	2X6	28.3	11	33	25
SSMG-P21/4X6	PG21	4X6	28.3	11	33	25
SSMG-P29/10X6	PG29	10X6	37	11	42	20
SSMG-P29/3X12	PG29	3X10	37	11	42	20
SSMG-P29/6X6	PG29	6X6	37	11	42	20
SSMG-P29/4X4.2	PG29	4X4.2	37	11	42	20
SSMG-P29/18X2.6	PG29	18X2.6	37	11	42	20
SSMG-P29/6X5.8	PG29	6X5.8	37	11	42	20
SSMG-P29/10X2.6	PG29	10X2.6	37	11	42	20
SSMG-P29/18X3.5	PG29	18X3.5	37	11	42	20
SSMG-P29/5X5.1	PG29	5X5.1	37	11	42	20
SSMG-P29/25X3.5	PG29	25X3.5	37	11	42	20
SSMG-P36/2X15	PG36	2X15	47	13	52	10
SSMG-P36/9X7	PG36	9X7	47	13	52	10
SSMG-P36/10X5	PG36	10X5	47	13	52	10
SSMG-P36/45X2.6	PG36	45X2.6	47	13	52	10
SSMG-P36/8X7.5	PG36	8X7.5	47	13	52	10
SSMG-P36/32X3.5	PG36	32X3.5	47	13	52	10
SSMG-P36/20X2.5	PG36	20X2.5	47	13	52	10
SSMG-P36/55X2.6	PG36	55X2.6	47	13	52	10
SSMG-P42/4X13	PG42	4X13	54	14	60	10
SSMG-P48/5X12	PG48	5X12	59.3	15	65	5



## SSMP系列

### 圆形金属闷盖 Metal Screw Plug

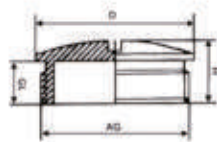

材料: 黄铜镀镍  
Material: Nickel-plated brass

#### SSMP-M 公制螺纹 Metric Thread

订货编号 Article No.	螺纹规格 Thread Dimension	螺纹外径 AG mm	螺纹长度 GL mm	闷盖外径 D mm	包装单位 Packet units
SSMP-M10	M10X1.0	10	5	12	100
SSMP-M12	M12X1.5	12	5	14	100
SSMP-M16	M16X1.5	16	6	18	100
SSMP-M18	M18X1.5	18	6	21	100
SSMP-M20	M20X1.5	20	7	23	100
SSMP-M22	M22X1.5	22	7	25	100
SSMP-M24	M24X1.5	24	7	27	100
SSMP-M25	M25X1.5	25	7	28	100
SSMP-M27	M27X2.0	27	7	29.5	100
SSMP-M30	M30X2.0	30	7	32.5	50
SSMP-M32	M32X1.5	32	8	35	50
SSMP-M36	M36X2.0	36	8	38.5	50
SSMP-M40	M40X1.5	40	9	44	25
SSMP-M48	M48X2.0	48	9	52	25
SSMP-M50	M50X1.5	50	10	54	25
SSMP-M63	M63X1.5	63	10	67	25
SSMP-M64	M64X2.0	64	10	68	25

#### SSMP-P 德制螺纹 PG Thread

订货编号 Article No.	螺纹规格 Thread Dimension	螺纹外径 AG mm	螺纹长度 GL mm	闷盖外径 D mm	包装单位 Packet units
SSMP-P7	PG7	12.5	5	14	100
SSMP-P9	PG9	15.2	6	17	100
SSMP-P11	PG11	18.6	6	21	100
SSMP-P13	PG13.5	20.4	7	23	100
SSMP-P16	PG16	22.5	7	25	100
SSMP-P21	PG21	28.3	7	31	100
SSMP-P29	PG29	37	8	40	50
SSMP-P36	PG36	47	9	50	25
SSMP-P42	PG42	57	10	57	25
SSMP-P48	PG48	59.3	10	64	25

## SSMPX系列

### 六角形金属闷盖 Hexagon Brass Screw Plug

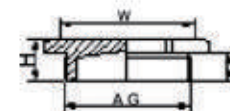

材料: 黄铜镀镍  
Material: Nickel-plated brass

#### SSMP-M 公制螺纹 Metric Thread

订货编号 Article No.	螺纹规格 Thread Dimension	螺纹外径 AG mm	螺纹长度 GL mm	闷盖外径 D mm	包装单位 Packet units
SSMPX-M10	M10x1.0	10	5	12	100
SSMPX-M12	M12x1.5	12	5	14	100
SSMPX-M16	M16x1.5	16	6	18	100
SSMPX-M18	M18x1.5	18	6	20	100
SSMPX-M20	M20x1.5	20	7	22	100
SSMPX-M22	M22x1.5	22	7	25	100
SSMPX-M24	M24x1.5	24	7	27	100
SSMPX-M25	M25x1.5	25	7	28	100
SSMPX-M27	M27x2.0	27	7	30	100
SSMPX-M30	M30x2.0	30	7	34	50
SSMPX-M32	M32x1.5	32	8	36	50
SSMPX-M36	M36x2.0	36	8	40	50
SSMPX-M40	M40x1.5	40	9	45	25
SSMPX-M48	M48x2.0	48	9	55	25
SSMPX-M50	M50x1.5	50	10	55	25
SSMPX-M63	M63x1.5	63	10	70	25
SSMPX-M64	M64x2.0	64	10	70	25

#### SSMP-P 德制螺纹 PG Thread

订货编号 Article No.	螺纹规格 Thread Dimension	螺纹外径 AG mm	螺纹长度 GL mm	闷盖外径 D mm	包装单位 Packet units
SSMPX-P7	PG7	12.5	5	14	100
SSMPX-P9	PG9	15.2	6	17	100
SSMPX-P11	PG11	18.6	6	20	100
SSMPX-P13	PG13.5	20.4	7	22	100
SSMPX-P16	PG16	22.5	7	24	100
SSMPX-P21	PG21	28.3	7	30	100
SSMPX-P29	PG29	37	8	40	50
SSMPX-P36	PG36	47	9	50	25
SSMPX-P42	PG42	57	10	60	25
SSMPX-P48	PG48	59.3	10	65	25



## SSMA系列

### 金属变径接头 Metal Reducer & Enlarger

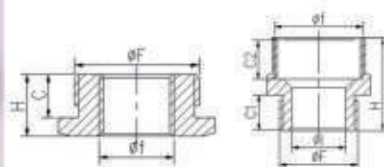

材料: 黄铜镀镍  
Material: Nickel-plated brass

#### SSMA-M 公制螺纹转德制螺纹 Metric Thread to PG Thread

订货编号 Article No.	外螺纹规格 Outer Thread mm	内螺纹规格 Inner Thread mm	外螺纹长度 Thread Length mm	总长 Total Length mm	扳手尺寸 Wrench mm	形式 Form
SSMA-M16/P7	M16x1.5	PG7	6	8.5	18	A
SSMA-M16/P9	M16x1.5	PG9	6	16.5	19	B
SSMA-M16/P11	M16x1.5	PG11	6	16.5	19	B
SSMA-M18/P9	M18x1.5	PG9	6	16.5	21	B
SSMA-M18/P11	M18x1.5	PG11	6	16.5	22	B
SSMA-M18/P13	M18x1.5	PG13.5	6	16.5	24	B
SSMA-M20/P11	M20x1.5	PG11	7	17.5	24	B
SSMA-M20/P13	M20x1.5	PG13.5	7	17.5	24	B
SSMA-M20/P16	M20x1.5	PG16	7	20	27	B
SSMA-M25/P16	M25x1.5	PG16	7	20	27	B
SSMA-M25/P1621	M25x1.5	PG21	7	25	32	B
SSMA-M27/P13	M27x2.0	PG13.5	7	10	30	A
SSMA-M27/P16	M27x2.0	PG16	7	10	30	A
SSMA-M32/P16	M32x1.5	PG16	8	11.5	36	A
SSMA-M32/P21	M32x1.5	PG21	8	11.5	36	A
SSMA-M32/P29	M32x1.5	PG29	8	23.5	40	B
SSMA-M40/P29	M40x1.5	PG29	9	25	45	B
SSMA-M40/P36	M40x1.5	PG36	9	27.5	50	B
SSMA-M50/P21	M50x1.5	PG21	10	14	55	A
SSMA-M50/P29	M50x1.5	PG29	10	14	55	A

#### SSMA-P 德制螺纹转公制螺纹 PG Thread to Metric Thread

订货编号 Article No.	外螺纹规格 Outer Thread mm	内螺纹规格 Inner Thread mm	外螺纹长度 Thread Length mm	总长 Total Length mm	扳手尺寸 Wrench mm	形式 Form
SSMA-P9/M16	PG9	M16x1.5	6	16.5	20	B
SSMA-P9/M20	PG9	M20x1.5	6	17.5	24	B
SSMA-P11/M20	PG11	M20x1.5	6	17.5	24	B
SSMA-P13/M20	PG13.5	M20x1.5	7	18	24	B
SSMA-P16/M20	PG16	M20x1.5	7	18	24	B
SSMA-P16/M25	PG16	M25x1.5	7	19	28	B
SSMA-P21/M25	PG21	M25x1.5	7	19	32	B
SSMA-P21/M32	PG21	M32x1.5	7	20	36	B
SSMA-P21/M40	PG21	M40x1.5	7	23	45	B
SSMA-P29/M40	PG29	M40x1.5	8	24	45	B
SSMA-P36/M50	PG36	M50x1.5	9	25	55	B
SSMA-P42/M50	PG42	M50x1.5	10	31	66	B

## SSMG系列

### 不锈钢电缆防水接头 Stainless Steel Cable Gland

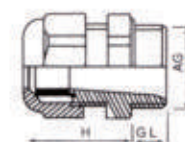

材料: 外部金属为SU304, 内部芯套为尼龙, 密封件材料为改性橡胶, 可根据需要定制硅胶和三元乙丙橡胶材料。  
 防护等级: 在规定的卡口范围内, 并使用合适的O型密封圈, 防护等级可以达到IP68。  
 温度范围: 静态: -40°C-100°C, 短时间可达120°C  
 动态: -20°C-80°C, 短时间可达100°C  
 Material: Body: Stainless Steel SU304. Inner parts: Nylon 6; Sealing: NBR  
 Protection degree: Using suitable O-sealing within the clamping range, The protection degree can reach IP68  
 Temperature Range: Stat.: Min-40°C, Max100°C, Short-term120°C  
 Dyn.: Min-20°C, Max80°C, Short-term100°C

#### SSMG-ST-M 公制螺纹 Metric Thread

订货编号 Article No.	螺纹规格 Thread Dimension	卡口范围 Clamping range mm	外径尺寸 AG mm	螺纹长度 GL mm	扳手尺寸 Wrench size mm	包装数量 Packet pcs
SSMG-ST	Dimension	mm	mm	mm	mm	pcs
SSMG-ST-M8	M8x1.0	2-3.5	8	5.5	12/12	75
SSMG-ST-M10	M10x1.0	3-6.5	10	6	14/14	75
SSMG-ST-M12	M12x1.5	3-6.5	12	6	14/14	75
SSMG-ST-M14	M16x1.5	3-6.5	16	7	14/18	75
SSMG-ST-M16	M16x1.5	4-8	16	7	17/18	75
SSMG-ST-M16D	M16x1.5	5-10	16	7	20/20	50
SSMG-ST-M18	M18x1.5	5-10	18	7	20/20	50
SSMG-ST-M20X	M20x1.5	5-10	20	7	20/22	32
SSMG-ST-M20	M20x1.5	6-12	20	7	22/22	32
SSMG-ST-M20D	M20x1.5	10-14	20	7	24/24	32
SSMG-ST-M22	M22x1.5	10-14	22	7	24/24	32
SSMG-ST-M24	M24x1.5	10-14	24	7	24/27	32
SSMG-ST-M25X	M25x1.5	10-14	25	7	24/27	18
SSMG-ST-M25	M25x1.5	10-16	25	7	28/28	18
SSMG-ST-M25D	M25x1.5	13-18	25	7	30/30	18
SSMG-ST-M27X	M27x2.0	10-16	27	8	28/30	18
SSMG-ST-M27	M27x2.0	13-18	27	8	30/30	18
SSMG-ST-M30X	M30x2.0	10-16	30	8	28/34	18
SSMG-ST-M30	M30x2.0	13-18	30	8	30/34	18
SSMG-ST-M32X	M32x1.5	13-18	32	8	30/36	18
SSMG-ST-M32	M32x1.5	15-22	32	8	36/36	18
SSMG-ST-M32D	M32x1.5	18-25	32	8	40/38	8
SSMG-ST-M33	M32x2.0	15-22	33	8	40/38	8
SSMG-ST-M36	M36x2.0	15-22	36	8	36/40	8
SSMG-ST-M36D	M36x2.0	18-25	36	8	40/40	8
SSMG-ST-M40	M40x1.5	22-30	40	9	45/45	8
SSMG-ST-M40D	M40x1.5	22-32	40	9	50/50	4
SSMG-ST-M42	M42x2.0	22-28	42	9	50/50	4
SSMG-ST-M48	M48x2.0	22-32	48	9	50/52	4
SSMG-ST-M50D	M50x1.5	30-38	50	9	58/55	4
SSMG-ST-M56	M56x2.0	30-38	56	9	58/60	4
SSMG-ST-M60	M60x2.0	37-44	60	10	65/65	2
SSMG-ST-M63	M63x1.5	37-44	63	10	65/70	2
SSMG-ST-M63D	M63x1.5	42-53	63	10	75/75	2
SSMG-ST-M64	M64x2.0	37-44	64	10	65/70	2



## SSMG-ST-M-L 加长型公制螺纹 Lengthened Metric Thread

订货编号 Article No.	螺纹规格 Thread	卡口范围 Clamping range	外径尺寸 AG	螺纹长度 GL	扳手尺寸 Wrench size	包装数量 Packet
SSMG-ST	Dimension	mm	mm	mm	mm	pcs
SSMG-ST-M8-L	M8x1.0	2-3.5	8	10	12/12	50
SSMG-ST-M10-L	M10x1.0	3-6.5	10	10	14/14	50
SSMG-ST-M12-L	M12x1.5	3-6.5	12	10	14/14	50
SSMG-ST-M14-L	M16x1.5	3-6.5	16	10	14/18	50
SSMG-ST-M16-L	M16x1.5	4-8	16	10	17/18	50
SSMG-ST-M16D-L	M16x1.5	5-10	16	10	20/20	50
SSMG-ST-M18-L	M18x1.5	5-10	18	10	20/20	50
SSMG-ST-M20X-L	M20x1.5	5-10	20	10	20/22	32
SSMG-ST-M20-L	M20x1.5	6-12	20	10	22/22	32
SSMG-ST-M20D-L	M20x1.5	10-14	20	10	24/24	32
SSMG-ST-M22-L	M22x1.5	10-14	22	10	24/24	32
SSMG-ST-M24-L	M24x1.5	10-14	24	12	24/27	32
SSMG-ST-M25X-L	M25x1.5	10-14	25	12	24/27	18
SSMG-ST-M25-L	M25x1.5	10-16	25	12	28/28	18
SSMG-ST-M25D-L	M25x1.5	13-18	25	12	30/30	18
SSMG-ST-M27X-L	M27x2.0	10-16	27	12	28/30	18
SSMG-ST-M27-L	M27x2.0	13-18	27	12	30/30	18
SSMG-ST-M30X-L	M30x2.0	10-16	30	12	28/34	18
SSMG-ST-M30-L	M30x2.0	13-18	30	12	30/34	18
SSMG-ST-M32X-L	M32x1.5	13-18	32	12	30/36	18
SSMG-ST-M32-L	M32x1.5	15-22	32	12	36/36	18
SSMG-ST-M32D-L	M32x1.5	18-25	32	12	40/38	8
SSMG-ST-M33-L	M32x2.0	15-22	33	12	40/38	8
SSMG-ST-M36-L	M36x2.0	15-22	36	12	36/40	8
SSMG-ST-M36D-L	M36x2.0	18-25	36	12	40/40	8
SSMG-ST-M40-L	M40x1.5	22-30	40	15	45/45	8
SSMG-ST-M40D-L	M40x1.5	22-32	40	15	50/50	4
SSMG-ST-M42-L	M42x2.0	22-28	42	15	50/50	4
SSMG-ST-M48-L	M48x2.0	22-32	48	15	50/52	4
SSMG-ST-M50D-L	M50x1.5	30-38	50	15	58/55	4
SSMG-ST-M56-L	M56x2.0	30-38	56	15	58/60	4
SSMG-ST-M60-L	M60x2.0	37-44	60	15	65/65	2
SSMG-ST-M63-L	M63x1.5	37-44	63	15	65/70	2
SSMG-ST-M63D-L	M63x1.5	42-53	63	15	75/75	2
SSMG-ST-M64-L	M64x2.0	37-44	64	15	65/70	2

## SSMG-ST-P 德制螺纹 PG Thread

订货编号 Article No.	螺纹规格 Thread	卡口范围 Clamping range	外径尺寸 AG	螺纹长度 GL	扳手尺寸 Wrench size	包装数量 Packet
SSMG-ST	Dimension	mm	mm	mm	mm	pcs
SSMG-ST-P7	Pg7	3-6.5	12.5	6	14/14	75
SSMG-ST-P9	Pg9	4-8	15.2	7	17/17	75
SSMG-ST-P11	Pg11	5-10	18.6	7	20/20	75
SSMG-ST-P13X	Pg13.5	5-10	20.4	7	20/22	32
SSMG-ST-P13	Pg13.5	6-12	20.4	7	22/22	32
SSMG-ST-P16	Pg16	6-12	20.4	7	22/24	32
SSMG-ST-P16	Pg16	10-14	22.5	7	24/24	32
SSMG-ST-P21	Pg21	10-16	28.3	7	28/30	18
SSMG-ST-P21	Pg21	13-18	28.3	7	30/30	18
SSMG-ST-P29X	Pg29	15-22	37	8	36/40	8
SSMG-ST-P29	Pg29	18-25	37	8	40/40	8
SSMG-ST-P36	Pg36	22-32	47	9	50/50	4
SSMG-ST-P42	Pg42	30-38	54	9	58/58	2
SSMG-ST-P48	Pg48	37-44	59.3	10	65/65	2
SSMG-ST-P63	Pg63	42-53	72	10	78/78	2

## SSMG系列

## 不锈钢电缆防水接头 Stainless Steel Cable Gland

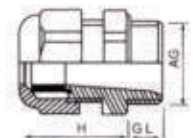

材料: 外部金属为SU304, 内部芯套为尼龙, 密封件材料为改性橡胶, 可根据需要定制硅胶和三元乙丙橡胶材料。  
 防护等级: 在规定的卡口范围内, 并使用合适的O型密封圈, 防护等级可以达到IP68。  
 温度范围: 静态: -40°C-100°C, 短时间可达120°C  
 动态: -20°C-80°C, 短时间可达100°C  
 Material: Body: Stainless Steel SU304. Inner parts: Nylon 6; Sealing: NBR  
 Protection degree: Using suitable O-sealing within the clamping range, The protection degree can reach IP68  
 Temperature Range: Stat.: Min-40°C, Max100°C, Short-term120°C  
 Dyn.: Min-20°C, Max80°C, Short-term100°C

## SSMG-ST-P-L 加长型德制螺纹 Lengthened PG Thread

订货编号 Article No.	螺纹规格 Thread	卡口范围 Clamping range	外径尺寸 AG	螺纹长度 GL	扳手尺寸 Wrench size	包装数量 Packet
SSMG-ST	Dimension	mm	mm	mm	mm	pcs
SSMG-ST-P7-L	Pg7	3-6.5	12.5	10	14/14	75
SSMG-ST-P9-L	Pg9	4-8	15.2	10	17/17	75
SSMG-ST-P11-L	Pg11	5-10	18.6	10	20/20	75
SSMG-ST-P13X-L	Pg13.5	5-10	20.4	10	20/22	32
SSMG-ST-P13-L	Pg13.5	6-12	20.4	10	22/22	32
SSMG-ST-P16X-L	Pg16	6-12	20.4	10	22/24	32
SSMG-ST-P16-L	Pg16	10-14	22.5	10	24/24	32
SSMG-ST-P21X-L	Pg21	10-16	28.3	12	28/30	18
SSMG-ST-P21-L	Pg21	13-18	28.3	12	30/30	18
SSMG-ST-P29X-L	Pg29	15-22	37	12	36/40	8
SSMG-ST-P29-L	Pg29	18-25	37	12	40/40	8
SSMG-ST-P36-L	Pg36	22-32	47	15	50/50	4
SSMG-ST-P42-L	Pg42	30-38	54	15	58/58	2
SSMG-ST-P48-L	Pg48	37-44	59.3	15	65/65	2
SSMG-ST-P63-L	Pg63	42-53	72	15	78/78	2

## SSMG-ST-G 管螺纹G Thread

订货编号 Article No.	螺纹规格 Thread	卡口范围 Clamping range	外径尺寸 AG	螺纹长度 GL	扳手尺寸 Wrench size	包装数量 Packet
SSMG-ST	Dimension	mm	mm	mm	mm	pcs
SSMG-ST-G1/4	G1/4"	3-6.5	13.157	8	14/14	75
SSMG-ST-G3/8	G3/8"	4-8	16.662	8	17/20	75
SSMG-ST-G1/2X	G1/2"	5-10	20.995	8	20/24	32
SSMG-ST-G1/2	G1/2"	6-12	20.995	8	22/24	32
SSMG-ST-G1/2D	G1/2"	8-14	20.995	8	24/24	32
SSMG-ST-G3/4X	G3/4"	6-12	26.441	8	22/30	18
SSMG-ST-G3/4	G3/4"	8-14	26.441	8	24/30	18
SSMG-ST-G3/4D	G3/4"	13-18	26.441	8	30/30	18
SSMG-ST-G1	G1"	18-25	33.249	9	40/40	8
SSMG-ST-G1-1/4	G1-1/4"	22-32	41.910	10	50/50	4
SSMG-ST-G1-1/2	G1-1/2"	32-38	47.803	10	58/55	2
SSMG-ST-G2	G2"	37-44	59.614	11	65/65	2
SSMG-ST-G3	G3"	65-71	87.88	25	96/96	1
SSMG-ST-G4	G4"	86-93	113.03	25	126/126	1



## SSMG-ST-NPT美制螺纹NPT Thread

订货编号 Article No.	螺纹规格 Thread	卡口范围 Clamping range	外径尺寸 AG	螺纹长度 GL	扳手尺寸 Wrench size	包装数量 Packet
SSMG-ST	Dimension	mm	mm	mm	mm	pcs
SSMG-N1/4	NPT1/4"	3-6.5	13.616	13	14/14	50
SSMG-N3/8	NPT 3/8"	4-8	17.055	13	17/20	50
SSMG-N1/2	NPT 1/2"	5-10	21.223	13	20/23	32
SSMG-N1/2	NPT 1/2"	6-12	21.223	13	22/23	32
SSMG-N1/2	NPT 1/2"	8-14	21.223	13	24/24	32
SSMG-N3/4	NPT 3/4"	8-14	26.568	13	24/30	18
SSMG-N3/4	NPT 3/4"	13-18	26.568	13	30/30	18
SSMG-N1	NPT 1"	18-25	33.228	16	40/40	8
SSMG-N1-1/4	NPT 1-1/4"	22-32	41.988	16	50/50	4
SSMG-N1-1/2	NPT 1-1/2"	32-38	48.054	18	58/55	2
SSMG-N2	NPT 2"	37-44	60.092	18	65/65	1
SSMG-ST-N3	NPT3"	65-71	88.60	28	96/96	1
SSMG-ST-N4	NPT4"	86-93	113.54	28	126/126	1

## SSMG-ST-M公制螺纹Metric Thread

订货编号 Article No.	螺纹规格 Thread	卡口范围 Clamping range	外径尺寸 AG	螺纹长度 GL	扳手尺寸 Wrench size	包装数量 Packet
SSMG-ST	Dimension	mm	mm	mm	mm	pcs
SSMG-ST-M63-TD	M63x1.5	52-57	63	10	80/80	2
SSMG-ST-M72-X	M72x2.0	52-57	72	12	80/80	2
SSMG-ST-M72	M72x2.0	55-61	72	12	86/86	2
SSMG-ST-M75-X	M75x2.0	52-57	75	12	86/86	2
SSMG-ST-M75	M75x2.0	55-61	75	12	86/86	2
SSMG-ST-M80-X	M80x2.0	52-57	80	12	86/86	2
SSMG-ST-M80	M80x2.0	55-61	80	12	86/86	2
SSMG-ST-M80-D	M80x2.0	60-66	80	12	90/90	2
SSMG-ST-M85	M85x2.0	60-66	85	12	90/90	2
SSMG-ST-M88	M88x2.0	65-71	88	12	90/90	2
SSMG-ST-M90	M90x2.0	65-71	90	12	100/100	1
SSMG-ST-M100-X	M100x2.0	65-71	100	15	112/112	1
SSMG-ST-M100	M100x2.0	74-80	100	25	112/112	1
SSMG-ST-M110	M110x2.0	80-86	110	25	120/115	1
SSMG-ST-M114	M114x2.0	86-93	114	25	126/126	1
SSMG-ST-M125	M125x2.0	95-102	125	25	138/138	1

## SSMN系列

## 金属螺母



材料: 黄铜镀镍  
Material: Nickel-plated brass

## SSMP-M 公制螺纹 Metric Thread

订货编号 Article No.	螺纹规格 Thread	扳手尺寸 Wrench	厚度 Thickness	包装单位 Packet
SSMN-M10	M10x1.0	12	2.5	100
SSMN-M12	M12x1.5	14	2.5	100
SSMN-M16	M16x1.5	18	2.8	100
SSMN-M18	M18x1.5	20	3.0	100
SSMN-M20	M20x1.5	22	3.0	100
SSMN-M22	M22x1.5	24	3.2	100
SSMN-M24	M24x1.5	27	3.2	100
SSMN-M25	M25x1.5	27	3.2	100
SSMN-M27	M27x2.0	30	3.3	100
SSMN-M30	M30x2.0	34	3.3	100
SSMN-M32	M32x1.5	35	3.5	100
SSMN-M33	M33x2.0	36	3.5	100
SSMN-M36	M36x2.0	40	4.0	100
SSMN-M40	M40x1.5	43	4.5	50
SSMN-M42	M42x2.0	45	4.5	50
SSMN-M48	M48x2.0	52	5.0	50
SSMN-M50	M50x1.5	55	5.0	50
SSMN-M56	M56x2.0	60	5.0	50
SSMN-M63	M63x1.5	68	5.5	25
SSMN-M64	M64x2.0	68	5.5	25
SSMN-M72	M72x2.0	78	6.0	25
SSMN-M75	M75x2.0	83	6.0	25
SSMN-M80	M80x1.5	88	6.5	25
SSMN-M100	M100x1.5	110	8.0	25

## SSMP-P 德制螺纹 PG Thread

订货编号 Article No.	螺纹规格 Thread	扳手尺寸 Wrench	厚度 Thickness	包装单位 Packet
SSMN-P7	PG7	14	2.5	100
SSMN-P9	PG9	19	2.8	100
SSMN-P11	PG11	21	3.0	100
SSMN-P13	PG13.5	23	3.0	100
SSMN-P16	PG16	25	3.2	100
SSMN-P21	PG21	31	3.3	500
SSMN-P29	PG29	40	4.0	500
SSMN-P36	PG36	50	5.0	50
SSMN-P42	PG42	58	5.0	50
SSMN-P48	PG48	64	5.5	25
SSMN-P63	PG63	78	6.0	25





### 电缆防水接头系列 Cable Gland Series

塑料篇 Plastic

金属篇 Metal

### ▶ 塑料波纹管及接头系列 Plastic Flexible Conduit & Fitting

软管接头及配件 Fitting & Accessory

金属软管及接头 Metal Flexible Conduit & Fitting

塑料工程拖链 Plastic Cable Drag Chain

散热防水透气阀 Breathable Vent Plug

塑料冷却水管 Cooling Tube

## SSPA系列

### 尼龙波纹管 Nylon Flexible Conduit

材料: 尼龙6

颜色: 黑色/灰色, 其它颜色接受定制。

温度: -40°C-115°C。

特性: 柔韧性好, 表面有光泽, 抗扭曲, 低烟无卤, 耐油、碱、弱酸等, 耐紫外线。

应用场合: 适用于轨道交通, 汽车线束, 电气控制系统, 机械制造等。

Material: Polyamide 6

Color: Black/Gray, Other colors accept customization

Temperature: -40°C-115°C。

Properties: Flexible, shiny surface, anti-twist, low smoke and halogen-free, oil, alkali, weak acid, etc., resistant to UV

Applications: Suitable for rail transit, automotive wiring harness, electrical control systems, machinery manufacturing, etc.



订货编号 Article	内径x外径 IDxOD mm	静态弯曲半径 Stat.r mm	动态弯曲半径 Dyn.r mm	包装 (米/卷) Packing m/roll
SSPA-AD10-B/G	7.0x10.0	13	35	100
SSPA-AD11.6-B/G	8.1x11.6	15	40	100
SSPA-AD13-B/G	10.0x13.0	20	45	100
SSPA-AD15.8-B/G	12.0x15.8	35	55	100
SSPA-AD18.5-B/G	14.3x18.5	40	65	100
SSPA-AD20-B/G	16.0x20.0	45	75	50
SSPA-AD21.2-B/G	17.0x21.2	45	75	50
SSPA-AD25-B/G	20.0x25.0	50	85	50
SSPA-AD28.5-B/G	23.0x28.5	55	100	50
SSPA-AD34.5-B/G	29.0x34.5	65	120	25
SSPA-AD42.5-B/G	36.0x42.5	90	150	25
SSPA-AD54.5-B/G	48.0x54.5	100	190	25
SSPA-AD67.2-B/G	56.3x67.2	130	270	20
SSPA-AD80-B/G	66.5x80.0	170	310	20

波纹管  
Flexible Conduit

SSPA系列-阻燃尼龙波纹管  
Fire resistant UL94- Nylon Flexible Conduit



## SSPA系列

### 阻燃V0尼龙波纹软管 Fire resistant UL94-V0 Nylon Flexible Conduit

材料: 尼龙6  
颜色: 黑色/灰色, 其它颜色接受定制。  
温度: -40°C-115°C。  
特性: 柔韧性好, 表面有光泽, 抗扭曲, 低烟无卤, 耐油、碱、弱酸等, 耐紫外线。  
阻燃等级: UL94-V0  
应用场合: 适用于轨道交通, 汽车线束, 电气控制系统, 机械制造等。  
Material: Polyamide 6  
Color: Black/Gray, Other colors accept customization  
Temperature: -40°C-115°C。  
Properties: Flexible ,shiny surface, anti-twist, low smoke and halogen-free, oil, alkali, weak acid, etc., resistant to UV  
Fire resistant: UL94-V0  
Applications: Suitable for rail transit, automotive wiring harness, electrical control systems, machinery manufacturing, etc.



通过EN45545和DIN5510测试

订货编号 Article	内径x外径 IDxOD mm	静态弯曲半径 Stat.r mm	动态弯曲半径 Dyn.r mm	包装 (米/卷) Packing m/roll
SSPA-AD10-V0-B/G	7.0x10.0	13	35	100
SSPA-AD11.6-V0-B/G	8.1x11.6	15	40	100
SSPA-AD13-V0-B/G	10.0x13.0	20	45	100
SSPA-AD15.8-V0-B/G	12.0x15.8	35	55	100
SSPA-AD18.5-V0-B/G	14.3x18.5	40	65	100
SSPA-AD20-V0-B/G	16.0x20.0	45	75	50
SSPA-AD21.2-V0-B/G	17.0x21.2	45	75	50
SSPA-AD25-V0-B/G	20.0x25.0	50	85	50
SSPA-AD28.5-V0-B/G	23.0x28.5	55	100	50
SSPA-AD34.5-V0-B/G	29.0x34.5	65	120	25
SSPA-AD42.5-V0-B/G	36.0x42.5	90	150	25
SSPA-AD54.5-V0-B/G	48.0x54.5	100	190	25
SSPA-AD67.2-V0-B/G	56.3x67.2	130	270	20
SSPA-AD80-V0-B/G	66.5x80.0	170	310	20

## SSPA系列

### 阻燃V2尼龙波纹软管 Fire resistant UL94-V2 Nylon Flexible Conduit

材料: 尼龙6  
颜色: 黑色/灰色, 其它颜色接受定制。  
温度: -40°C-115°C。  
特性: 柔韧性好, 表面有光泽, 抗扭曲, 低烟无卤, 耐油、碱、弱酸等, 耐紫外线。  
阻燃等级: UL94-V2  
应用场合: 适用于轨道交通, 汽车线束, 电气控制系统, 机械制造等。  
Material: Polyamide 6  
Color: Black/Gray, Other colors accept customization  
Temperature: -40°C-115°C。  
Properties: Flexible ,shiny surface, anti-twist, low smoke and halogen-free, oil, alkali, weak acid, etc., resistant to UV  
Fire resistant: UL94-V2  
Applications: Suitable for rail transit, automotive wiring harness, electrical control systems, machinery manufacturing, etc.



订货编号 Article	内径x外径 IDxOD mm	静态弯曲半径 Stat.r mm	动态弯曲半径 Dyn.r mm	包装 (米/卷) Packing m/roll
SSPA-AD10-V2-B/G	7.0x10.0	13	35	100
SSPA-AD11.6-V2-B/G	8.1x11.6	15	40	100
SSPA-AD13-V2-B/G	10.0x13.0	20	45	100
SSPA-AD15.8-V2-B/G	12.0x15.8	35	55	100
SSPA-AD18.5-V2-B/G	14.3x18.5	40	65	100
SSPA-AD20-V2-B/G	16.0x20.0	45	75	50
SSPA-AD21.2-V2-B/G	17.0x21.2	45	75	50
SSPA-AD25-V2-B/G	20.0x25.0	50	85	50
SSPA-AD28.5-V2-B/G	23.0x28.5	55	100	50
SSPA-AD34.5-V2-B/G	29.0x34.5	65	120	25
SSPA-AD42.5-V2-B/G	36.0x42.5	90	150	25
SSPA-AD54.5-V2-B/G	48.0x54.5	100	190	25
SSPA-AD67.2-V2-B/G	56.3x67.2	130	270	20
SSPA-AD80-V2-B/G	66.5x80.0	170	310	20



## SSPA系列

### 耐高温尼龙波纹软管 Nylon High Temperature resistant conduit

材料: 尼龙6  
颜色: 黑色/灰色, 其它颜色接受定制。  
温度: -40°C-150°C。  
特性: 柔韧性好, 表面有光泽, 抗扭曲, 低烟无卤, 耐油、碱、弱酸等, 耐紫外线。  
阻燃等级: UL94-V2  
应用场合: 适用于轨道交通, 汽车线束, 电气控制系统, 机械制造等。

Material: Polyamide 6  
Color: Black/Gray, Other colors accept customization  
Temperature: -40°C-150°C.

Properties: Flexible ,shiny surface, anti-twist, low smoke and halogen-free, oil, alkali, weak acid, etc., resistant to UV

Fire resistant: UL94-V2

Applications: Suitable for rail transit, automotive wiring harness, electrical control systems, machinery manufacturing, etc.



订货编号 Article	内径x外径 IDxOD mm	静态弯曲半径 Stat.r mm	动态弯曲半径 Dyn.r mm	包装 (米/卷) Packing m/roll
SSPA-AD10-H-B/G	7.0x10.0	13	35	100
SSPA-AD11.6-H-B/G	8.1x11.6	15	40	100
SSPA-AD13-H-B/G	10.0x13.0	20	45	100
SSPA-AD15.8-H-B/G	12.0x15.8	35	55	100
SSPA-AD18.5-H-B/G	14.3x18.5	40	65	100
SSPA-AD20-H-B/G	16.0x20.0	45	75	50
SSPA-AD21.2-H-B/G	17.0x21.2	45	75	50
SSPA-AD25-H-B/G	20.0x25.0	50	85	50
SSPA-AD28.5-H-B/G	23.0x28.5	55	100	50
SSPA-AD34.5-H-B/G	29.0x34.5	65	120	25
SSPA-AD42.5-H-B/G	36.0x42.5	90	150	25
SSPA-AD54.5-H-B/G	48.0x54.5	100	190	25
SSPA-AD67.2-H-B/G	56.3x67.2	130	270	20
SSPA-AD80-H-B/G	66.5x80.0	170	310	20

## SSPA系列

### 剖开型尼龙软管 Slit Nylon Flexible Conduit

材料: 尼龙6  
颜色: 黑色/灰色, 其它颜色接受定制。  
温度: -40°C-115°C。  
特性: 柔韧性好, 表面有光泽, 抗扭曲, 低烟无卤, 耐油、碱、弱酸等, 耐紫外线。  
应用场合: 适用于轨道交通, 汽车线束, 电气控制系统, 机械制造等。

Material: Polyamide 6  
Color: Black/Gray, Other colors accept customization  
Temperature: -40°C-115°C.

Properties: Flexible ,shiny surface, anti-twist, low smoke and halogen-free, oil, alkali, weak acid, etc., resistant to UV

Applications: Suitable for rail transit, automotive wiring harness, electrical control systems, machinery manufacturing, etc.



订货编号 Article	内径x外径 IDxOD mm	静态弯曲半径 Stat.r mm	动态弯曲半径 Dyn.r mm	包装 (米/卷) Packing m/roll
SSPA-AD10-S-B/G	7.0x10.0	13	35	100
SSPA-AD11.6-S-B/G	8.1x11.6	15	40	100
SSPA-AD13-S-B/G	10.0x13.0	20	45	100
SSPA-AD15.8-S-B/G	12.0x15.8	35	55	100
SSPA-AD18.5-S-B/G	14.3x18.5	40	65	100
SSPA-AD20-S-B/G	16.0x20.0	45	75	50
SSPA-AD21.2-S-B/G	17.0x21.2	45	75	50
SSPA-AD25-S-B/G	20.0x25.0	50	85	50
SSPA-AD28.5-S-B/G	23.0x28.5	55	100	50
SSPA-AD34.5-S-B/G	29.0x34.5	65	120	25
SSPA-AD42.5-S-B/G	36.0x42.5	90	150	25
SSPA-AD54.5-S-B/G	48.0x54.5	100	190	25
SSPA-AD67.2-S-B/G	56.3x67.2	130	270	20
SSPA-AD80-S-B/G	66.5x80.0	170	310	20



## SSPA系列

### 尼龙12软管 Nylon12 Flexible Conduit

材料: 尼龙12

颜色: 黑色/灰色, 其它颜色接受定制。

温度: -50°C-115°C。

特性: 耐低温, 柔韧性好, 表面有光泽, 抗扭曲, 低烟无卤, 耐油、碱、弱酸等, 耐紫外线, 优良的防UV, 耐候性及耐化学腐蚀性。

应用场合: 多用于机器人、工业自动化设备、航空航天设备、高铁地铁、轨道交通设备、化学工业、机械手臂、机床机械设备、电气绝缘保护系统等, 具有良好的机械应力, 在干燥寒冷环境下提供良好的线缆保护。

Material: Polyamide 12

Color: Black/Gray, Other colors accept customization

Temperature: -50°C-115°C。

Properties: Low temperature resistance, flexibility, glossy surface, anti-distortion, low smoke and halogen free, oil, alkali, weak acid, etc., UV resistance, excellent UV protection, weather resistance and chemical corrosion resistance.

Applications: Suitable for rail transit, automotive wiring harness, electrical control systems, machinery manufacturing, etc.



订货编号 Article	内径x外径 IDxOD mm	静态弯曲半径 Stat.r mm	动态弯曲半径 Dyn.r mm	包装 (米/卷) Packing m/roll
SSPA12-AD10-S-B/G	7.0x10.0	13	35	100
SSPA12-AD11.6-S-B/G	8.1x11.6	15	40	100
SSPA12-AD13-S-B/G	10.0x13.0	20	45	100
SSPA12-AD15.8-S-B/G	12.0x15.8	35	55	100
SSPA12-AD18.5-S-B/G	14.3x18.5	40	65	100
SSPA12-AD20-S-B/G	16.0x20.0	45	75	50
SSPA12-AD21.2-S-B/G	17.0x21.2	45	75	50
SSPA12-AD25-S-B/G	20.0x25.0	50	85	50
SSPA12-AD28.5-S-B/G	23.0x28.5	55	100	50
SSPA12-AD34.5-S-B/G	29.0x34.5	65	120	25
SSPA12-AD42.5-S-B/G	36.0x42.5	90	150	25
SSPA12-AD54.5-S-B/G	48.0x54.5	100	190	25
SSPA12-AD67.2-S-B/G	56.3x67.2	130	270	20
SSPA12-AD80-S-B/G	66.5x80.0	170	310	20

## SSPA系列

### 阻燃尼龙12软管 Fire resistant UL94-V2 Nylon12 Flexible Conduit

材料: 尼龙12

阻燃等级: V2(可定制V0)

颜色: 黑色/灰色, 其它颜色接受定制。

温度: -50°C-115°C。

特性: 耐低温, 柔韧性好, 表面有光泽, 抗扭曲, 低烟无卤, 耐油、碱、弱酸等, 耐紫外线, 优良的防UV, 耐候性及耐化学腐蚀性。

应用场合: 多用于机器人、工业自动化设备、航空航天设备、高铁地铁、轨道交通设备、化学工业、机械手臂、机床机械设备、电气绝缘保护系统等, 具有良好的机械应力, 在干燥寒冷环境下提供良好的线缆保护。

Material: Polyamide 12

Fire resistant: UL94-V2 (customized V0)

Color: Black/Gray, Other colors accept customization

Temperature: -50°C-115°C。

Properties: Low temperature resistance, flexibility, glossy surface, anti-distortion, low smoke and halogen free, oil, alkali, weak acid, etc., UV resistance, excellent UV protection, weather resistance and chemical corrosion resistance.

Applications: Suitable for rail transit, automotive wiring harness, electrical control systems, machinery manufacturing, etc.

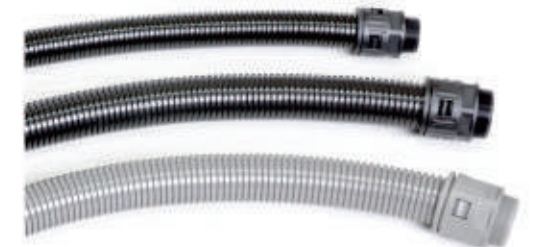

订货编号 Article	内径x外径 IDxOD mm	静态弯曲半径 Stat.r mm	动态弯曲半径 Dyn.r mm	包装 (米/卷) Packing m/roll
SSPA12-AD10-S-B/G	7.0x10.0	13	35	100
SSPA12-AD11.6-S-B/G	8.1x11.6	15	40	100
SSPA12-AD13-S-B/G	10.0x13.0	20	45	100
SSPA12-AD15.8-S-B/G	12.0x15.8	35	55	100
SSPA12-AD18.5-S-B/G	14.3x18.5	40	65	100
SSPA12-AD20-S-B/G	16.0x20.0	45	75	50
SSPA12-AD21.2-S-B/G	17.0x21.2	45	75	50
SSPA12-AD25-S-B/G	20.0x25.0	50	85	50
SSPA12-AD28.5-S-B/G	23.0x28.5	55	100	50
SSPA12-AD34.5-S-B/G	29.0x34.5	65	120	25
SSPA12-AD42.5-S-B/G	36.0x42.5	90	150	25
SSPA12-AD54.5-S-B/G	48.0x54.5	100	190	25
SSPA12-AD67.2-S-B/G	56.3x67.2	130	270	20
SSPA12-AD80-S-B/G	66.5x80.0	170	310	20



## SSPE系列

### 聚乙烯波纹软管 PE Flexible Conduit

材料: 聚乙烯

颜色: 黑色/灰色, 其它颜色接受定制。

温度: -50°C- 80°C。

特性: 柔韧性好, 表面有光泽, 抗扭曲, 低烟无卤, 耐油、碱、弱酸等, 耐紫外线。

应用场合: 适用于, 汽车线束, 电气控制系统, 机械制造等。

Material: Polyethylene

Color: Black/Gray, Other colors accept customization

Temperature: -50°C- 80°C.

Properties: Flexible, shiny surface, anti-twist, low smoke

and halogen-free, oil, alkali, weak acid, etc., resistant to UV

Applications: Suitable for automotive wiring harness, electrical control systems,

machinery manufacturing, etc.



订货编号 Article	内径x外径 IDxOD mm	静态弯曲半径 Stat.r mm	动态弯曲半径 Dyn.r mm	包装 (米/卷) Packing m/roll
SSPE-AD10-B/G	7.0x10.0	13	35	100
SSPE-AD11.6-B/G	8.1x11.6	15	40	100
SSPE-AD13-B/G	10.0x13.0	20	45	100
SSPE-AD15.8-B/G	12.0x15.8	35	55	100
SSPE-AD18.5-B/G	14.3x18.5	40	65	100
SSPE-AD20-B/G	16.0x20.0	45	75	50
SSPE-AD21.2-B/G	17.0x21.2	45	75	50
SSPE-AD25-B/G	20.0x25.0	50	85	50
SSPE-AD28.5-B/G	23.0x28.5	55	100	50
SSPE-AD34.5-B/G	29.0x34.5	65	120	25
SSPE-AD42.5-B/G	36.0x42.5	90	150	25
SSPE-AD54.5-B/G	48.0x54.5	100	190	25
SSPE-AD67.2-B/G	56.3x67.2	130	270	20
SSPE-AD80-B/G	66.5x80.0	170	310	20

## SSPE系列

### 阻燃型聚乙烯波纹软管 Fire resistant PE Flexible Conduit

材料: 聚乙烯

颜色: 黑色/灰色, 其它颜色接受定制。

温度: -50°C- 80°C。

阻燃等级: UL94-V0

特性: 柔韧性好, 表面有光泽, 抗扭曲, 低烟无卤, 耐油、碱、弱酸等, 耐紫外线。

应用场合: 适用于, 汽车线束, 电气控制系统, 机械制造等。

Material: Polyethylene

Color: Black/Gray, Other colors accept customization

Temperature: -50°C- 80°C.

Fire resistant: UL94-V0

Properties: Flexible, shiny surface, anti-twist, low smoke and halogen-free,

oil, alkali, weak acid, etc., resistant to UV

Applications: Suitable for automotive wiring harness, electrical

control systems, machinery manufacturing, etc.



订货编号 Article	内径x外径 IDxOD mm	静态弯曲半径 Stat.r mm	动态弯曲半径 Dyn.r mm	包装 (米/卷) Packing m/roll
SSPE-AD10-V0-B/G	7.0x10.0	13	35	100
SSPE-AD11.6-V0-B/G	8.1x11.6	15	40	100
SSPE-AD13-V0-B/G	10.0x13.0	20	45	100
SSPE-AD15.8-V0-B/G	12.0x15.8	35	55	100
SSPE-AD18.5-V0-B/G	14.3x18.5	40	65	100
SSPE-AD20-V0-B/G	16.0x20.0	45	75	50
SSPE-AD21.2-V0-B/G	17.0x21.2	45	75	50
SSPE-AD25-V0-B/G	20.0x25.0	50	85	50
SSPE-AD28.5-V0-B/G	23.0x28.5	55	100	50
SSPE-AD34.5-V0-B/G	29.0x34.5	65	120	25
SSPE-AD42.5-V0-B/G	36.0x42.5	90	150	25
SSPE-AD54.5-V0-B/G	48.0x54.5	100	190	25
SSPE-AD67.2-V0-B/G	56.3x67.2	130	270	20
SSPE-AD80-V0-B/G	66.5x80.0	170	310	20



## SSPE系列

### 剖开型聚乙烯波纹管 Slit PE Flexible Conduit

材料: 聚乙烯  
颜色: 黑色/灰色, 其它颜色接受定制。  
温度: -50°C- 80°C。  
特性: 柔韧性好, 表面有光泽, 抗扭曲, 低烟无卤, 耐油、碱、弱酸等, 耐紫外线。  
应用场合: 适用于, 汽车线束, 电气控制系统, 机械制造等。  
Material: Polyethylene  
Color: Black/Gray, Other colors accept customization  
Temperature: -50°C- 80°C.  
Properties: Flexible, shiny surface, anti-twist, low smoke and halogen-free, oil, alkali, weak acid, etc., resistant to UV  
Applications: Suitable for automotive wiring harness, electrical control systems, machinery manufacturing, etc.



订货编号 Article	内径x外径 IDxOD mm	静态弯曲半径 Stat.r mm	动态弯曲半径 Dyn.r mm	包装 (米/卷) Packing m/roll
SSPE-AD10-S-B/G	7.0x10.0	13	35	100
SSPE-AD11.6-S-B/G	8.1x11.6	15	40	100
SSPE-AD13-S-B/G	10.0x13.0	20	45	100
SSPE-AD15.8-S-B/G	12.0x15.8	35	55	100
SSPE-AD18.5-S-B/G	14.3x18.5	40	65	100
SSPE-AD20-S-B/G	16.0x20.0	45	75	50
SSPE-AD21.2-S-B/G	17.0x21.2	45	75	50
SSPE-AD25-S-B/G	20.0x25.0	50	85	50
SSPE-AD28.5-S-B/G	23.0x28.5	55	100	50
SSPE-AD34.5-S-B/G	29.0x34.5	65	120	25
SSPE-AD42.5-S-B/G	36.0x42.5	90	150	25
SSPE-AD54.5-S-B/G	48.0x54.5	100	190	25
SSPE-AD67.2-S-B/G	56.3x67.2	130	270	20
SSPE-AD80-S-B/G	66.5x80.0	170	310	20

## SSPP系列

### 聚丙烯波纹管 PP Flexible Conduit

材料: 聚丙烯  
颜色: 黑色/灰色, 其它颜色接受定制。  
温度: -40°C-110°C。  
特性: 耐油, 耐酸碱, 具有很好的化学耐腐蚀能力, 很好的机械强度, 硬度强。  
应用场合: 适用于汽车线束, 电气控制系统, 机械制造等。  
Material: Polypropylene  
Color: Black/Gray, Other colors accept customization  
Temperature: -40°C- 110°C.  
Properties: Resistant to oil, acid and alkali, has good chemical corrosion resistance, good mechanical strength, and strong hardness.  
Applications: Suitable for automotive wiring harness, electrical control systems, machinery manufacturing, etc.

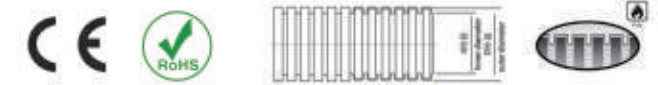

订货编号 Article	内径x外径 IDxOD mm	静态弯曲半径 Stat.r mm	动态弯曲半径 Dyn.r mm	包装 (米/卷) Packing m/roll
SSPP-AD10-B/G	7.0x10.0	13	35	100
SSPP-AD11.6-B/G	8.1x11.6	15	40	100
SSPP-AD13-B/G	10.0x13.0	20	45	100
SSPP-AD15.8-B/G	12.0x15.8	35	55	100
SSPP-AD18.5-B/G	14.3x18.5	40	65	100
SSPP-AD20-B/G	16.0x20.0	45	75	50
SSPP-AD21.2-B/G	17.0x21.2	45	75	50
SSPP-AD25-B/G	20.0x25.0	50	85	50
SSPP-AD28.5-B/G	23.0x28.5	55	100	50
SSPP-AD34.5-B/G	29.0x34.5	65	120	25
SSPP-AD42.5-B/G	36.0x42.5	90	150	25
SSPP-AD54.5-B/G	48.0x54.5	100	190	25
SSPP-AD67.2-B/G	56.3x67.2	130	270	20
SSPP-AD80-B/G	66.5x80.0	170	310	20



## SSPP系列

### 阻燃型聚丙烯波纹软管 Fire resistant PP Flexible Conduit

材料: 聚丙烯  
颜色: 黑色/灰色, 其它颜色接受定制。  
温度: -40°C-110°C,  
阻燃等级: UL94-V0

特性: 耐油, 耐酸碱, 具有很好的化学耐腐蚀能力, 很好的机械强度, 硬度强。  
应用场合: 适用于, 汽车线束, 电气控制系统, 机械制造等。

Material: Polypropylene  
Color: Black/Gray, Other colors accept customization  
Temperature: -40°C- 110°C.

Properties: Resistant to oil, acid and alkali, has good chemical corrosion resistance, good mechanical strength, and strong hardness...

Fire resistant: UL94-V0

Properties: Flexible ,shiny surface, anti-twist, low smoke and halogen-free, oil, alkali, weak acid, etc., resistant to UV

Applications: Suitable for automotive wiring harness, electrical control systems, machinery manufacturing, etc.

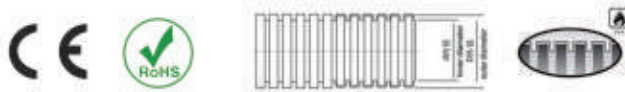

订货编号 Article	内径x外径 IDxOD mm	静态弯曲半径 Stat.r mm	动态弯曲半径 Dyn.r mm	包装 (米/卷) Packing m/roll
SSPP-AD10-V0-B/G	7.0x10.0	13	35	100
SSPP-AD11.6-V0-B/G	8.1x11.6	15	40	100
SSPP-AD13-V0-B/G	10.0x13.0	20	45	100
SSPP-AD15.8-V0-B/G	12.0x15.8	35	55	100
SSPP-AD18.5-V0-B/G	14.3x18.5	40	65	100
SSPP-AD20-V0-B/G	16.0x20.0	45	75	50
SSPP-AD21.2-V0-B/G	17.0x21.2	45	75	50
SSPP-AD25-V0-B/G	20.0x25.0	50	85	50
SSPP-AD28.5-V0-B/G	23.0x28.5	55	100	50
SSPP-AD34.5-V0-B/G	29.0x34.5	65	120	25
SSPP-AD42.5-V0-B/G	36.0x42.5	90	150	25
SSPP-AD54.5-V0-B/G	48.0x54.5	100	190	25
SSPP-AD67.2-V0-B/G	56.3x67.2	130	270	20
SSPP-AD80-V0-B/G	66.5x80.0	170	310	20

## SSPP系列

### 剖开型聚丙烯波纹软管 Slit PP Flexible Conduit

材料: 聚丙烯  
颜色: 黑色/灰色, 其它颜色接受定制。  
温度: -40°C-110°C,

特性: 耐油, 耐酸碱, 具有很好的化学耐腐蚀能力, 很好的机械强度, 硬度强。  
应用场合: 适用于, 汽车线束, 电气控制系统, 机械制造等。

Material: Polypropylene  
Color: Black/Gray, Other colors accept customization  
Temperature: -40°C- 110°C.

Properties: Resistant to oil, acid and alkali, has good chemical corrosion resistance, good mechanical strength, and strong hardness..

Applications: Suitable for automotive wiring harness, electrical control systems, machinery manufacturing, etc.



订货编号 Article	内径x外径 IDxOD mm	静态弯曲半径 Stat.r mm	动态弯曲半径 Dyn.r mm	包装 (米/卷) Packing m/roll
SSPP-AD10-S-B/G	7.0x10.0	13	35	100
SSPP-AD11.6-S-B/G	8.1x11.6	15	40	100
SSPP-AD13-S-B/G	10.0x13.0	20	45	100
SSPP-AD15.8-S-B/G	12.0x15.8	35	55	100
SSPP-AD18.5-S-B/G	14.3x18.5	40	65	100
SSPP-AD20-S-B/G	16.0x20.0	45	75	50
SSPP-AD21.2-S-B/G	17.0x21.2	45	75	50
SSPP-AD25-S-B/G	20.0x25.0	50	85	50
SSPP-AD28.5-S-B/G	23.0x28.5	55	100	50
SSPP-AD34.5-S-B/G	29.0x34.5	65	120	25
SSPP-AD42.5-S-B/G	36.0x42.5	90	150	25
SSPP-AD54.5-S-B/G	48.0x54.5	100	190	25
SSPP-AD67.2-S-B/G	56.3x67.2	130	270	20
SSPPS-AD80-S-B/G	66.5x80.0	170	310	20



## SSPE-D系列

### 尼龙双拼波纹软管 Nylon Double Flexible Conduit

材料: 聚乙烯

颜色: 黑色/灰色, 其它颜色接受定制。

温度: -50°C-85°C。

特性: 柔韧性好, 表面有光泽, 抗扭曲, 低烟无卤, 耐油、碱、弱酸等, 耐紫外线。

应用场合: 适用于轨道交通, 汽车线束, 电气控制系统, 机械制造等。

使用方法: 将电线电缆穿入管内, 再配合外管, 可反复使用, 方便检修和更换。

Material: Polythene

Color: Black/Gray, Other colors accept customization

Temperature: -50°C-85°C。

Properties: Flexible ,shiny surface, anti-twist, low smoke and halogen-free, oil, alkali, weak acid, etc., resistant to UV

Applications: Suitable for rail transit, automotive wiring harness, electrical control systems, machinery manufacturing, etc.

How to use: Wire and cables are insert into the tube, and then combined with the outer tube, it can be used repeatedly, which is convenient for maintenance and replacement.



订货编号 Article	内径x外径 IDxOD mm	最小弯曲半径 Stat.r mm	包装 (米/卷) Packing m/roll
SSPE-D-AD6-B/G	6.2x10.0	40	50
SSPE-D-AD10-B/G	8.8x13.5	55	50
SSPE-D-AD11-B/G	11.0x16.1	60	50
SSPE-D-AD14-B/G	12.5x18.5	75	50
SSPE-D-AD16-B/G	16.0x21.5	90	50
SSPE-D-AD20-B/G	20.0x22.5	105	50
SSPE-D-AD22-B/G	22.0x28.5	125	50
SSPE-D-AD23-B/G	24.0x31.5	140	50
SSPE-D-AD29-B/G	26.0x34.5	170	25
SSPE-D-AD37-B/G	32.0x42.5	175	25
SSPE-D-AD45-B/G	45.0x54.5	175	25
SSPE-D-AD70-B/G	67.0x80.0	200	10
SSPE-D-AD100-B/G	92.0x106	240	10

## SSPA-D系列

### 尼龙双拼波纹软管 Nylon Double Flexible Conduit

材料: 尼龙6

颜色: 黑色/灰色, 其它颜色接受定制。

温度: -40°C-125°C, 短时间到150°C。

特性: 柔韧性好, 表面有光泽, 抗扭曲, 低烟无卤, 耐油、碱、弱酸等, 耐紫外线。

应用场合: 适用于轨道交通, 汽车线束, 电气控制系统, 机械制造等。

使用方法: 将电线电缆穿入管内, 再配合外管, 可反复使用, 方便检修和更换。

Material: Polyamide 6

Color: Black/Gray, Other colors accept customization

Temperature: -40°C-125°C, short time to 150°C。

Properties: Flexible ,shiny surface, anti-twist, low smoke and halogen-free, oil, alkali, weak acid, etc., resistant to UV

Applications: Suitable for rail transit, automotive wiring harness, electrical control systems, machinery manufacturing, etc.

How to use: Wire and cables are insert into the tube, and then combined with the outer tube, it can be used repeatedly, which is convenient for maintenance and replacement.



订货编号 Article	内径x外径 IDxOD mm	最小弯曲半径 Stat.r mm	包装 (米/卷) Packing m/roll
SSPA-D-AD6-B/G	6.2x10.0	40	50
SSPA-D-AD10-B/G	8.8x13.5	55	50
SSPA-D-AD11-B/G	11.0x16.1	60	50
SSPA-D-AD14-B/G	12.5x18.5	75	50
SSPA-D-AD16-B/G	16.0x21.5	90	50
SSPA-D-AD20-B/G	20.0x22.5	105	50
SSPA-D-AD22-B/G	22.0x28.5	125	50
SSPA-D-AD23-B/G	24.0x31.5	140	50
SSPA-D-AD29-B/G	26.0x34.5	170	25
SSPA-D-AD37-B/G	32.0x42.5	175	25
SSPA-D-AD45-B/G	45.0x54.5	175	25
SSPA-D-AD70-B/G	67.0x80.0	200	10
SSPA-D-AD100-B/G	92.0x106	240	10



## SSPP-D系列

### 尼龙双拼波纹软管 Nylon Double Flexible Conduit

材料: 聚丙烯

颜色: 黑色/灰色, 其它颜色接受定制。

温度: -30°C-105°C。

特性: 耐油, 耐酸碱, 具有很好的化学耐腐蚀能力, 很好的机械强度, 硬度强。

应用场合: 适用于汽车线束, 电气控制系统, 机械制造等。

使用方法: 将电线电缆穿入管内, 再配合外管, 可反复使用, 方便检修和更换。

Material: Polypropylene

Color: Black/Gray, Other colors accept customization

Temperature: -30°C- 105°C.

Applications: Suitable for rail transit, automotive wiring harness, electrical control systems, machinery manufacturing, etc.

How to use: Wire and cables are insert into the tube, and then combined with the outer tube, it can be used repeatedly, which is convenient for maintenance and replacement.



订货编号 Article	内径x外径 IDxOD mm	最小弯曲半径 Stat.r mm	包装 (米/卷) Packing m/roll
SSPP-D-AD6-B/G	6.2x10.0	40	50
SSPP-D-AD10-B/G	8.8x13.5	55	50
SSPP-D-AD11-B/G	11.0x16.1	60	50
SSPP-D-AD14-B/G	12.5x18.5	75	50
SSPP-D-AD16-B/G	16.0x21.5	90	50
SSPP-D-AD20-B/G	20.0x22.5	105	50
SSPP-D-AD22-B/G	22.0x28.5	125	50
SSPP-D-AD23-B/G	24.0x31.5	140	50
SSPP-D-AD29-B/G	26.0x34.5	170	25
SSPP-D-AD37-B/G	32.0x42.5	175	25
SSPP-D-AD45-B/G	45.0x54.5	175	25
SSPP-D-AD70-B/G	67.0x80.0	200	10
SSPP-D-AD100-B/G	92.0x106	240	10



#### 电缆防水接头系列 Cable Gland Series

塑料篇 Plastic

金属篇 Metal

塑料波纹软管及接头系列 Plastic Flexible Conduit & Fitting

▶ 软管接头及配件 Fitting & Accessory

金属软管及接头 Metal Flexible Conduit & Fitting

塑料工程拖链 Plastic Cable Drag Chain

散热防水透气阀 Breathable Vent Plug

塑料冷却水管 Cooling Tube



## SSQC系列

## 快插式软管接头 Straight Quick fitting

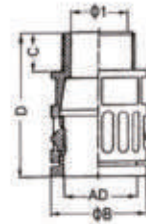

材料: PA6  
 温度范围: -40°C-105°C, 短时间可以达到150°C  
 防护等级: IP67, 使用合适的密封圈  
 Material: PA6  
 Temperature Range: Min-40°C, Max105°C, Short-term150°C  
 Protection degree: IP66, using suitable seals



## SSQC-AD/P PG制螺纹 PG Thread

订货编号 Article No	适配软管AD Fits to	螺纹规格 Thread	螺纹外径 Thread	螺纹长度C Thread	孔径 ΦI	外径 ΦB	长度D Total length	扳手尺寸 SW	包装数量 Package
注: 黑色(B), 灰色 (G)	Tubing size	Dimension	OD	Length	mm	mm	mm	wrench size	pcs
SSQC-AD10.0/P7(B/G)	AD10.0	PG7	12.5	10	7	17	35	15	100
SSQC-AD13.0/P9(B/G)	AD13.0	PG9	15.2	9.5	10	20.2	34.5	18	100
SSQC-AD15.8/P11(B/G)	AD15.8	PG11	18.6	9.5	12.5	23.2	36.5	21	100
SSQC-AD18.5/P13.5(B/G)	AD18.5	PG13.5	20.4	11	14	26.2	39.5	24	50
SSQC-AD21.2/P16(B/G)	AD21.2	PG16	22.5	13	17	29.7	44.5	27	50
SSQC-AD28.5/P21(B/G)	AD28.5	PG21	28.3	13	23.5	37.4	47.5	34	25
SSQC-AD34.5/P29(B/G)	AD34.5	PG29	37	12	30	44	48	40	20
SSQC-AD42.5/P36(B/G)	AD42.5	PG36	47	14	36	52	53	48	10
SSQC-AD54.5/P48(B/G)	AD54.5	PG48	59.3	14.5	48	64	54	59	5

## SSQC-AD/G G制螺纹 G Thrend

订货编号 Article No	适配软管AD Fits to	螺纹规格 Thread	螺纹长度C Thread	孔径 ΦI	外径 ΦB	长度D Total length	扳手尺寸 SW	包装数量 Package
注: 黑色(B), 灰色 (G)	Tubing size	Dimension	Length	mm	mm	mm	wrench size	pcs
SSQC-AD10.0/G1/4(B/G)	AD10.0	G1/4"	10	7	17	35	15	100
SSQC-AD13.0/G3/8(B/G)	AD13.0	G3/8"	9.5	10	20.2	34.5	18	100
SSQC-AD15.8/G3/8(B/G)	AD15.8	G3/8"	9.5	12	23.2	36.5	21	100
SSQC-AD15.8/G1/2(B/G)	AD15.8	G1/2"	11	12.5	26.2	36.5	24	100
SSQC-AD21.2/G1/2(B/G)	AD21.2	G1/2"	13	15	29.7	44.5	27	50
SSQC-AD28.5/G3/4(B/G)	AD28.5	G3/4"	13	20.5	37.4	47.5	34	25
SSQC-AD34.5/G1(B/G)	AD34.5	G1"	12	25.5	44	48	40	20
SSQC-AD42.5/G1 1/4(B/G)	AD42.5	G1 1/4"	14	35	52	53	49	10
SSQC-AD54.5/G1 1/2(B/G)	AD54.5	G1 1/2"	14.5	40	64	54	59	5
SSQC-AD54.5/G2(B/G)	AD54.5	G2"	14.5	48.5	64	54	50	5

## SSQC系列

## 快插式软管接头 Straight Quick fitting

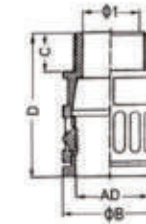

材料: PA6  
 温度范围: -40°C-105°C, 短时间可以达到150°C  
 防护等级: IP67, 使用合适的密封圈  
 Material: PA6  
 Temperature Range: Min-40°C, Max105°C, Short-term150°C  
 Protection degree: IP66, using suitable seals



## SSQC-AD/M 公制螺纹 Metric Thrend

订货编号 Article No	适配软管AD Fits to	螺纹规格 Thread	螺纹长度C Thread	孔径 ΦI	外径 ΦB	长度D Total length	扳手尺寸 SW	包装数量 Package
注: 黑色(B), 灰色 (G)	Tubing size	Dimension	Length	mm	mm	mm	wrench size	pcs
SSQC-AD10.0/M12(B/G)	AD10.0	M12×1.5	10	7.0	17	34.5	15	100
SSQC-AD13.0/M16(B/G)	AD10.0	M16×1.5	9.5	10	20.2	36	18	100
SSQC-AD15.8/M18(B/G)	AD15.8	M18×1.5	9.5	12	23.2	38	21	100
SSQC-AD18.5/M20(B/G)	AD18.5	M20×1.5	11	14.5	26.2	40	24	50
SSQC-AD20.0/M20(B/G)	AD20.0	M20×1.5	13	16	29.0	45	27	50
SSQC-AD21.2/M20(B/G)	AD21.2	M20×1.5	13	15.5	29.7	45	27	50
SSQC-AD21.2/M24(B/G)	AD21.2	M24×1.5	13	17	29.7	45	27	50
SSQC-AD21.2/M25(B/G)	AD21.2	M25×1.5	13	17	29.7	45	27	50
SSQC-AD25.0/M25(B/G)	AD25.0	M25×1.5	13	20	33.0	45	30	50
SSQC-AD28.5/M25(B/G)	AD28.5	M25×1.5	13	20.5	37.4	48	34	25
SSQC-AD28.5/M27(B/G)	AD28.5	M27×2.0	13	22.5	37.4	48	34	25
SSQC-AD28.5/M30(B/G)	AD28.5	M30×2.0	13	23.5	37.4	48	34	25
SSQC-AD28.5/M32(B/G)	AD28.5	M32×1.5	13	23.5	37.4	48	34	25
SSQC-AD34.5/M32(B/G)	AD34.5	M32×1.5	12	26	44	51	40	20
SSQC-AD34.5/M36(B/G)	AD34.5	M36×2.0	12	30	44	51	40	20
SSQC-AD34.5/M40(B/G)	AD34.5	M40×1.5	12	28.5	44	51	40	20
SSQC-AD42.5/M40(B/G)	AD42.5	M40×1.5	14	33	52	54	48	10
SSQC-AD42.5/M48(B/G)	AD42.5	M48×2.0	14	36.5	52	54	48	10
SSQC-AD42.5/M50(B/G)	AD42.5	M50×1.5	14	36.5	52	54	48	10
SSQC-AD54.5/M50(B/G)	AD54.5	M50×1.5	14.5	43	64	55	59	5
SSQC-AD54.5/M63(B/G)	AD54.5	M63×1.5	14.5	43	64	55	59	5



## SQW系列

### 直角快插式软管接头 90 Deg Quick Fitting

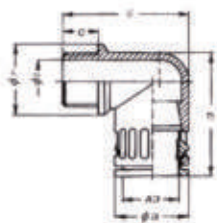

材料: PA6  
温度范围: -40°C-105°C, 短时间150°C  
防护等级: IP66, 使用合适的密封圈  
Material: PA6  
Temperature Range: Min-40°C, Max105°C, Short-term150°C  
Protection degree: IP66 using suitable seals.



#### SQW-AD/M 直角快速接头 90 Deg Quick Connector

订货编号 Article No.	适配软管AD Fits to	螺纹规格 Thread	ΦI ID	ΦB OD	C Thread length	D Total height	E Total length	ΦF Conne- ction	包装数量 Package pcs
注: 黑色(B), 灰色 (G)	Tubing size	Dimension	mm	mm	mm	mm	mm	mm	pcs
SQW-AD10.0/M10(B/G)	AD10.0	M10×1.0	7	17	10	33.5	32	16	100
SQW-AD13.0/M12(B/G)	AD13.0	M12×1.5	8	20.2	10	36	34	20	100
SQW-AD15.8/M16(B/G)	AD15.8	M16×1.5	12	23.2	10	42	47	23.2	50
SQW-AD18.5/M16(B/G)	AD18.5	M18×1.5	14	26.2	11	45	44	27	50
SQW-AD21.2/M20(B/G)	AD21.2	M20×1.5	15.5	29.7	13	50	49	29.7	25
SQW-AD25.0/M25(B/G)	AD25.0	M25×1.5	18	33.0	13	57	56.2	34.2	25
SQW-AD28.5/M25(B/G)	AD28.5	M25×1.5	18	37.5	13	57	56.2	34.2	20
SQW-AD34.5/M32(B/G)	AD34.5	M32×1.5	24	44	12	67.5	63	43	10
SQW-AD42.5/M40(B/G)	AD42.5	M40×1.5	32	52	12	83	70	52	5
SQW-AD54.5/M50(B/G)	AD54.5	M50×1.5	39	64	14	88	83	64	5
SQW-AD54.5/M63(B/G)	AD54.5	M63×1.5	53	64	14	88	83	64	5

#### SQW-AD/P 直角快速接头 Quick Elbow Connector

订货编号 Article No.	适配软管AD Fits to	螺纹规格 Thread	ΦI ID	ΦB OD	C Thread length	D Total height	E Total length	ΦF Conne- ction	包装数量 Package pcs
注: 黑色(B), 灰色 (G)	Tubing size	Dimension	mm	mm	mm	mm	mm	mm	pcs
SQW-AD10.0/P7(B/G)	AD10.0	PG7	8.5	17	10	33.5	32	16	100
SQW-AD13.0/P9(B/G)	AD13.0	PG9	12	20.2	10	36	34	20	100
SQW-AD15.8/P11(B/G)	AD15.8	PG11	15.5	23.2	10	42	37	23.2	50
SQW-AD18.5/P13.5(B/G)	AD18.5	PG13.5	13.5	26.2	11	46	44	27	50
SQW-AD21.2/P16(B/G)	AD21.2	PG16	18	29.7	12	50	49	29.7	25
SQW-AD28.5/P21(B/G)	AD28.5	PG21	24	37.5	12	57	56.2	34.2	20
SQW-AD34.5/P29(B/G)	AD34.5	PG29	32	44	12	67.5	63	43	10
SQW-AD42.5/P36(B/G)	AD42.5	PG36	36.5	52	12	83	70	52	5
SQW-AD54.5/P48(B/G)	AD54.5	PG48	48.5	64	14	88	83	64	5

## SSEG系列

### 45°快插式软管接头 45 Deg Quick Fitting



材料: PA6  
温度范围: -40°C-105°C, 短时间可达150°C。  
防护等级: IP66, 使用合适的密封圈。  
Material: PA6  
Temperature: -40°C-105°C.  
Protection degree: IP66, using suitable seals.



#### 45°快插式软管接头 公制螺纹 45 Deg Quick Fitting Metric Thread

订货编号 Article No.	适配软管AD Fits to	螺纹规格 Thread	螺纹外径 Thread OD	螺纹长度C Thread Length	孔径 ΦI mm	外径 ΦB mm	长度D Total length mm	包装数量 Package pcs
SSEG-AD15.8/M16(B/G)	AD15.8	M16×1.5	16	12	12	23.2	57	50
SSEG-AD15.8/M20(B/G)	AD15.8	M20×1.5	20	12	12	23.2	57	50
SSEG-AD21.2/M20(B/G)	AD21.2	M20×1.5	20	13	17	29.7	72	25
SSEG-AD34.5/M32(B/G)	AD34.5	M32×1.5	32	14	30	44	99	10
SSEG-AD34.5/M40(B/G)	AD34.5	M40×1.5	40	14	30	44	99	10

#### 45°快插式软管接头 德制螺纹 45 Degree Quick Fitting PG Thread

订货编号 Article No.	适配软管AD Fits to	螺纹规格 Thread	螺纹外径 Thread OD	螺纹长度C Thread Length	孔径 ΦI mm	外径 ΦB mm	长度D Total length mm	包装数量 Package pcs
SSEG-AD15.8/P11(B/G)	AD15.8	PG11	18.6	12	12	23.2	57	50
SSEG-AD21.2/P13(B/G)	AD21.2	PG13.5	20.4	13	17	29.7	73	25
SSEG-AD21.2/P16(B/G)	AD21.2	PG16	22.5	13	17	29.7	73	25
SSEG-AD34.5/P29(B/G)	AD34.5	PG29	37	14	30	44	99	10



## SSVG系列

### 可开式V型三通接头 Operable V distributor SSVG



材质: 尼龙6  
防护等级: IP40  
温度: -40°C- 105°C  
颜色: 黑色  
特点: 拆装方便, 价格实惠。  
Material: Nylon 6  
Protection Degree: IP40  
Temperature: -40°C- 105°C  
Color: Black  
Features: convenient disassembly and cheap.

### SQW-AD/M 直角快速接头 90 Deg Quick Connector

订货编号	适配软管规格	A	B	包装数量
Article No.	Fit to conduit	mm	mm	Package
SSVG-131313	AD13/13/13	55	37.3	50
SSVG-161313	AD15.8/13/13	55.6	41.3	50
SSVG-161613	AD15.8/15.8/13	55.6	41.5	50
SSVG-211313	AD21.2/13/13	43.5	39.5	50
SSVG-211613	AD21.2/15.8/13	48.7	37.2	50
SSVG-211616	AD21.2/15.8/15.8	59.2	46	50
SSVG-211613	AD21.2/15.8/13	59.2	46	25
SSVG-212116	AD21.2/21.2/15.8	63.5	47.5	25
SSVG-282113	AD28.5/21.2/13	54.5	52	20
SSVG-282116	AD28.5/21.2/15.8	55.2	51.7	20
SSVG-282116	AD28.5/21.2/15.8	55.2	51.7	20
SSVG-282813	AD28.5/28.5/13	68.5	57.7	20
SSVG-282821	AD28.5/28.5/21.2	78	61.5	20
SSVG-342828	AD34.5/28.5/28.5	88.4	67.4	20

## SSFC系列

### 法兰式大口径软管接头 Flange Conduit Fitting

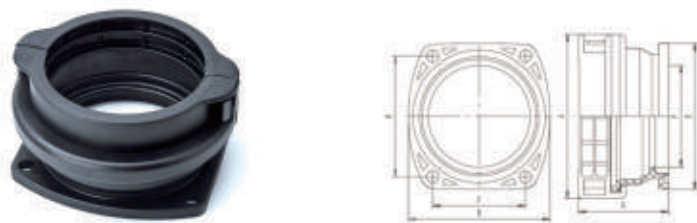

材料: PA6  
温度范围: -40°C~ 105°C, 短时间可达150°C,  
防护等级: IP54  
Material: PA6  
Temperature: -40°C-105°C,  
Protection degree: IP54



订货编号	适配软管AD	A	B	C	D	φE	φF	G	安装螺钉
Article No.	Fits to	mm	mm	mm	mm	mm	mm	mm	mm
SSFC-AD67(B/G)	AD67.2	94	80	53	69	83	52	52	M6
SSFC-AD80(B/G)	AD80.0	110	94	60	80	96	68	60	M6

## SSYG系列

### Y型三通快速接头 Quick Y-distributor Connector



材料: PA6  
温度范围: -40°C-120°C, 短时间150°C  
Material: PA6  
Temperature Range: Min-40°C, Max120°C, Short-term150°C



### SQW-AD/M 直角快速接头 90 Deg Quick Connector

订货编号	软管1	软管2	外径1	外径2	总长	总宽	安装孔	包装数量
Article No	AD1	AD2	B1	B2	D	C	ΦF	Package
注: 黑色(B),灰色(G)	mm	mm	mm	mm	mm	mm	mm	pcs
SSYG-AD10.0/2×10.0(B/G)	10.0	2x10.0	17.0	17.0	50	37	1x4.0	20
SSYG-AD13.0/2×10.0(B/G)	13.0	2x10.0	17.0	17.0	50	37	1x4.0	20
SSYG-AD13.0/2×13.0(B/G)	13.0	2x13.0	17.0	17.0	50	37	1x4.0	20
SSYG-AD15.8/2×13.0(B/G)	15.8	2x13.0	17.0	17.0	50	37	1x4.0	20
SSYG-AD15.8/2×15.8(B/G)	15.8	2x15.8	23	23	50	37	1x4.0	20
SSYG-AD18.5/2×18.5(B/G)	18.5	2x18.5	26.2	26.2	75	56	1x4.0	20
SSYG-AD21.2/2×21.2(B/G)	21.2	2x21.2	29.7	29.7	76.5	63	1x4.0	10
SSYG-AD21.2/2×15.8(B/G)	21.2	2x15.8	29.7	23	76.5	63	1x4.0	10
SSYG-AD28.5/2×15.8(B/G)	28.5	2x15.8	37.4	23	76.5	63	1x4.0	10
SSYG-AD28.5/2×21.2(B/G)	28.5	2x21.2	37.4	29.7	76.5	63	1x4.0	10

### SSWFC直角法兰式大口径软管接头 90 Deg Flange Conduit Fitting



材料: PA6  
温度范围: -40°C~ 105°C, 短时间可达150°C,  
防护等级: IP54  
Material: PA6  
Temperature: -40°C-105°C,  
Protection degree: IP54



订货编号	适配软管AD	孔径	总高	安装螺钉
Article No.	Fits to	φmm	mm	mm
SSWFC-AD80(B/G)	AD80	74	149	M6



## HQG系列

## 拧紧接头 Screw Fitting



材料: PA6  
温度范围: -40°C~105°C, 短时间可达150°C,  
防护等级: IP54  
Material: PA6  
Temperature: -40°C-105°C,  
Protection degree: IP54



## HQG-M 公制螺纹

订货编号 Article No.	适配软管 Fit to conduit	螺纹规格 Thread Dimension	外径 φ1	螺纹长度GL Thread Length	长度H Total Length	包装数量 Package
黑 (B) 灰 (G)	mm	mm	mm	mm	mm	pcs
HQG-AD10/M10(B/G)	AD10.0	M10x1.0	11	8	16	100
HQG-AD10/M12(B/G)	AD10.0	M12x1.5	11	8	16	100
HQG-AD13/M16(B/G)	AD13.0	M16x1.5	14	8	16	100
HQG-AD16/M16(B/G)	AD15.8	M16x1.5	17	8	16	100
HQG-AD16/M18(B/G)	AD15.8	M18x1.5	17	8	16	100
HQG-AD18/M18(B/G)	AD18.5	M18x1.5	19	8	16.5	100
HQG-AD18/M20(B/G)	AD18.5	M20x1.5	19	8	16.5	100
HQG-AD21/M20(B/G)	AD21.2	M20x1.5	22	8	26	50
HQG-AD21/M24(B/G)	AD21.2	M24x1.5	22	8	26	50
HQG-AD28/M25(B/G)	AD28.5	M25x1.5	29	10	32	25
HQG-AD28/M27(B/G)	AD28.5	M27x2.0	29	10	32	25
HQG-AD28/M30(B/G)	AD28.5	M30x2.0	29	10	32	25
HQG-AD34/M32(B/G)	AD34.5	M32x1.5	35	10	38.5	20
HQG-AD34/M36(B/G)	AD34.5	M36x2.0	35	10	38.5	20
HQG-AD42/M40(B/G)	AD42.5	M40x1.5	43.5	14	44.5	10
HQG-AD42/M48(B/G)	AD42.5	M48x2.0	43.5	14	44.5	10
HQG-AD54/M50(B/G)	AD54.5	M50x1.5	55	16	48	5
HQG-AD54/M63(B/G)	AD54.5	M63x1.5	55	16	48	5

## HQG-P 德制螺纹

订货编号 Article No.	适配软管 Fit to conduit	螺纹规格 Thread Dimension	外径 φ1	螺纹长度GL Thread Length	长度H Total Length	包装数量 Package
黑 (B) 灰 (G)	mm	mm	mm	mm	mm	pcs
HQG-AD10/P7(B/G)	AD10.0	PG7	11	8	16	100
HQG-AD13/P9(B/G)	AD13.0	PG9	14	8	16	100
HQG-AD16/P11(B/G)	AD15.8	PG11	17	8	16	100
HQG-AD18/P13(B/G)	AD18.5	PG13.5	19	8	16.5	100
HQG-AD21/PG16(B/G)	AD21.2	PG16	22	8	26	50
HQG-AD28/P21(B/G)	AD28.5	PG21	29	10	32	25
HQG-AD34/P29(B/G)	AD34.5	PG29	35	10	38.5	20
HQG-AD42/P36(B/G)	AD42.5	PG36	43.5	14	44.5	10
HQG-AD54/P48(B/G)	AD54.5	PG48	55	16	48	5

## SSNG系列

## 内螺纹快插式接头 Inner Thread Quick Fitting



材料: PA6  
温度范围: -40°C-105°C, 短时间可以达到150°C  
防护等级: IP67, 使用合适的密封圈  
Material: PA6  
Temperature Range: Min-40°C, Max105°C, Short-term150°C  
Protection degree: IP66, using suitable seals



## 德制螺纹 PG Thread

订货编号 Article No.	适配软管 Fit to	螺纹尺寸 φ	螺纹长度 C	扳手尺寸 SW	外径 φB	总长 D	包装数量 Package
黑 (B) 灰 (G)	AD	mm	mm	mm	mm	mm	pcs
SSNG-AD10/P7(B/G)	AD10.0	PG7	11.6	15	17	35	100
SSNG-AD13/P9(B/G)	AD13.0	PG9	13	18	20.2	38	100
SSNG-AD15.8/P11(B/G)	AD15.8	PG11	14	21	23.2	41.2	50
SSNG-AD18.5/P13(B/G)	AD18.5	PG13.5	14.5	24	26.2	42	50
SSNG-AD21.2/P16(B/G)	AD21.2	PG16	16	27	29.7	48	50
SSNG-AD28.5/P21(B/G)	AD28.5	PG21	20	34	37.4	54	25
SSNG-AD34.5/P29(B/G)	AD34.5	PG29	20	40	44	56	20
SSNG-AD42.5/P36(B/G)	AD42.5	PG36	20	48	51.8	59	10
SSNG-AD54.5/P42(B/G)	AD54.5	PG42	20	59	64	59	5
SSNG-AD54.5/P48(B/G)	AD54.5	PG48	20	59	64	59	5

## 公制螺纹 Metric Thread

订货编号 Article No.	适配软管 Fit to	螺纹尺寸 φ	螺纹长度 C	扳手尺寸 SW	外径 φB	总长 D	包装数量 Package
黑 (B) 灰 (G)	AD	mm	mm	mm	mm	mm	pcs
SSNG-AD10/M12(B/G)	AD10.0	M12x1.5	11.6	15	17	35	100
SSNG-AD13/M16(B/G)	AD13.0	M16x1.5	13	18	20.2	38	100
SSNG-AD15.8/M18(B/G)	AD15.8	M18x1.5	14	21	23.2	41.2	50
SSNG-AD18.5/M20(B/G)	AD18.5	M20x1.5	14.5	24	26.2	42	50
SSNG-AD21.2/M20(B/G)	AD21.2	M20x1.5	16	27	29.7	48	50
SSNG-AD28.5/M25(B/G)	AD28.5	M25x1.5	20	34	37.4	54	25
SSNG-AD34.5/M32(B/G)	AD34.5	M32x1.5	20	40	44	56	20
SSNG-AD42.5/M40(B/G)	AD42.5	M40x1.5	20	48	51.8	59	10
SSNG-AD54.5/M50(B/G)	AD54.5	M50x1.5	20	59	64	59	5
SSNG-AD54.5/M63(B/G)	AD54.5	M63x1.5	20	59	64	59	5



## SSKG系列

### 卡套式快插接头



材料: PA6  
温度范围: -40°C-105°C, 短时间可以达到150°C

Material: PA6  
Temperature Range: Min-40°C, Max105°C, Short-term150°C  
Protection degree: IP66, using suitable seals

订货编号 Article No.	适配软管 Fit to	卡口尺寸 Φ	外径 φl	长度 C	扳手尺寸 SW	外径B φB	总长 D	包装数量 Package
黑 (B) 灰 (G)	AD	mm	mm	mm	mm	mm	mm	pcs
SSKG-AD15.8	AD15.8	16	22	11.5	21	23.2	40	100
SSKG-AD21.2	AD21.2	20	26.4	11.5	27	29.5	44.5	50
SSKG-AD28.5	AD28.5	25	32.2	13.2	34	37.4	49	25
SSKG-AD34.5	AD34.5	32	39.5	13	40	44	51	20
SSKG-AD42.5	AD42.5	40	51.5	14	48	51.8	55.5	10
SSKG-AD54.5	AD54.5	50.2	60.2	15.2	59.5	64	57.5	5

## SSMQC系列

### 金属螺纹软管接头 Metal Thread Quick Fitting

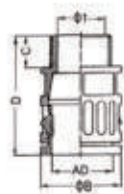

材料: 主体塑料部分为PA6, 金属螺纹部分为黄铜镀镍  
温度范围: -40°C-105°C, 短时间可以达到150°C

Material: The Plastic part is nylon6, the metal part is brass.  
Temperature Range: Min-40°C, Max105°C, Short-term150°C  
Protection degree: IP66, using suitable seals

订货编号 Article No.	适配软管 Fit to	螺纹尺寸 Φ	螺纹长度 C	扳手尺寸 SW	外径B φB	总长 D	包装数量 Package
黑 (B) 灰 (G)	AD	mm	mm	mm	mm	mm	pcs
SSMQC-AD10/M12(B/G)	AD10.0	M12x1.5	10	15	17	34.5	100
SSMQC-AD13/M16(B/G)	AD13.0	M16x1.5	10	18	20.2	36	100
SSMQC-AD15.8/M16(B/G)	AD15.8	M16x1.5	12	21	23.2	38	50
SSMQC-AD15.8/M20(B/G)	AD15.8	M20x1.5	12	21	23.2	38	50
SSMQC-AD18.5/M20(B/G)	AD18.5	M20x1.5	12	24	26.2	40	50
SSMQC-AD21.2/M20(B/G)	AD21.2	M20x1.5	13	27	29.7	45	25
SSMQC-AD28.5/M25(B/G)	AD28.5	M25x1.5	13	34	37.4	48	20
SSMQC-AD28.5/M32(B/G)	AD28.5	M32x1.5	13	34	37.4	48	20
SSMQC-AD34.5/M32(B/G)	AD34.5	M32x1.5	13	40	44	52	10
SSMQC-AD34.5/M32(B/G)	AD34.5	M32x1.5	13	40	44	52	10
SSMQC-AD34.5/M40(B/G)	AD34.5	M40x1.5	13	40	44	52	10
SSMQC-AD42.5/M40(B/G)	AD42.5	M40x1.5	14	48	51.8	54	10
SSMQC-AD42.5/M50(B/G)	AD42.5	M50x1.5	14	48	51.8	54	5
SSMQC-AD54.5/M50(B/G)	AD54.5	M50x1.5	14	59	64	55	5
SSMQC-AD54.5/M63(B/G)	AD54.5	M63x1.5	14	59	64	55	5

## SSMRG系列

### 90°金属螺纹接头90°Metal Thread Fitting

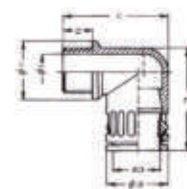

材料: 主体塑料部分为PA6, 金属螺纹部分为黄铜镀镍  
温度范围: -40°C-105°C, 短时间可以达到150°C

Material: The Plastic part is nylon6, the metal part is brass.  
Temperature Range: Min-40°C, Max105°C, Short-term150°C  
Protection degree: IP66, using suitable seals

### SSMRG-M 公制螺纹 Metric Thread

订货编号 Article No.	适配软管 Fit to	螺纹规格 Thread	孔径ΦI ID	外径ΦB OD	螺纹长C Thread length	总高D Total height	包装数量 Package
黑 (B) 灰 (G)	AD	Dimension	mm	mm	length	height	pcs
SSMRG-AD15.8/M16(B/G)	AD15.8	M16x1.5	12	23.2	12	38	50
SSMRG-AD15.8/M20(B/G)	AD15.8	M20x1.5	12	23.2	12	38	50
SSMRG-AD21.2/M20(B/G)	AD21.2	M20x1.5	17	29.7	13	45	25
SSMRG-AD34.5/M32(B/G)	AD34.5	M32x1.5	26	44	13	52	36
SSMRG-AD34.5/M40(B/G)	AD34.5	M40x1.5	28.5	44	13	52	36

### SSMRG-PG 德制螺纹 PG Thread

订货编号 Article No.	适配软管 Fit to	螺纹规格 Thread	孔径ΦI ID	外径ΦB OD	螺纹长C Thread length	总高D Total height	包装数量 Package
黑 (B) 灰 (G)	AD	Dimension	mm	mm	length	height	pcs
SSMRG-AD15.8/P11(B/G)	AD15.8	PG11	12	23.2	12	38	50
SSMRG-AD21.2/P13(B/G)	AD21.2	PG13.5	17	29.7	13	45	25
SSMRG-AD21.2/P16(B/G)	AD21.2	PG16	17	29.7	13	45	25
SSMRG-AD34.5/P29(B/G)	AD34.5	PG29	26	44	13	52	36



## SSMRG系列

### 45°金属螺纹接头 45° Metal Thread Fitting



材料: 主体塑料部分为PA6, 金属螺纹部分为黄铜镀镍  
温度范围:-40°C-105°C, 短时间可以达到150°C

Material: The Plastic part is nylon6, the metal part is brass.  
Temperature Range: Min-40°C, Max105°C, Short-term150°C  
Protection degree: IP66, using suitable seals



#### SSMRG -M 公制螺纹 Metric Thread

订货编号 Article No.	适配软管 Fit to	螺纹规格 Thread	孔径ΦI ID	外径ΦB OD	螺纹长C Thread length	总高D Total height	包装数量 Package pcs
黑 (B) 灰 (G)	AD	Dimension	mm	mm	length	height	pcs
SSMRG-AD15.8/M16(B/G)	AD15.8	M16x1.5	12	23.2	12	57	50
SSMRG-AD15.8/M20(B/G)	AD15.8	M20x1.5	12	23.2	12	57	50
SSMRG-AD21.2/M20(B/G)	AD21.2	M20x1.5	17	29.7	13	72	25
SSMRG-AD34.5/M32(B/G)	AD34.5	M32x1.5	30	44	14	99	48
SSMRG-AD34.5/M40(B/G)	AD34.5	M40x1.5	30	44	14	99	48

#### SSMRG -PG 德制螺纹 PG Thread

订货编号 Article No.	适配软管 Fit to	螺纹规格 Thread	孔径ΦI ID	外径ΦB OD	螺纹长C Thread length	总高D Total height	包装数量 Package pcs
黑 (B) 灰 (G)	AD	Dimension	mm	mm	length	height	pcs
SSMRG-AD15.8/P11(B/G)	AD15.8	PG11	12	23.2	12	38	50
SSMRG-AD21.2/P13(B/G)	AD21.2	PG13.5	17	29.7	13	45	25
SSMRG-AD21.2/P16(B/G)	AD21.2	PG16	17	29.7	13	45	25
SSMRG-AD34.5/P29(B/G)	AD34.5	PG29	26	44	13	52	36

## SSMNG系列

### 金属内螺纹软管接头 Metal Inner Thread Quick Fitting

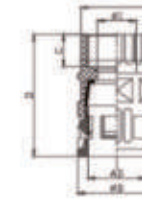

材料: 主体塑料部分为PA6, 金属螺纹部分为黄铜镀镍  
温度范围:-40°C-105°C, 短时间可以达到150°C

Material: The Plastic part is nylon6, the metal part is brass.  
Temperature Range: Min-40°C, Max105°C, Short-term150°C  
Protection degree: IP66, using suitable seals



#### 德制螺纹 PG Thread

订货编号 Article No.	适配软管 Fit to	螺纹尺寸 φ	螺纹长度 C	扳手尺寸 SW	外径 φB	总长 D	包装数量 Package pcs
黑 (B) 灰 (G)	AD	mm	mm	mm	mm	mm	pcs
SSMNG-AD10/PG7(B/G)	AD10.0	PG7	10	15	17	34.5	100
SSMNG-AD13/PG9(B/G)	AD13.0	PG9	10	18	20.2	36	100
SSMNG-AD15.8/PG11(B/G)	AD15.8	PG11	12	21	23.2	38	50
SSMNG-AD18.5/PG13(B/G)	AD18.5	PG13.5	12	24	26.2	40	50
SSMNG-AD21.2/PG16(B/G)	AD21.2	PG16	13	27	29.7	45	25
SSMNG-AD28.5/PG21(B/G)	AD28.5	PG21	13	34	37.4	48	20
SSMNG-AD34.5/PG29(B/G)	AD34.5	PG29	13	40	44	52	10
SSMNG-AD42.5/PG36(B/G)	AD42.5	PG36	14	48	51.8	54	10
SSMNG-AD54.5/PG42(B/G)	AD54.5	PG42	14	59	64	55	5
SSMNG-AD54.5/PG48(B/G)	AD54.5	PG48	14	59	64	55	5

#### 公制螺纹 Metric Thread

订货编号 Article No.	适配软管 Fit to	螺纹尺寸 φ	螺纹长度 C	扳手尺寸 SW	外径 φB	总长 D	包装数量 Package pcs
黑 (B) 灰 (G)	AD	mm	mm	mm	mm	mm	pcs
SSMNG-AD10/M12(B/G)	AD10.0	M12x1.5	6.5	15	17	36.5	100
SSMNG-AD13/M16(B/G)	AD13.0	M16x1.5	7.5	18	20.2	38.5	100
SSMNG-AD15.8/M18(B/G)	AD15.8	M18x1.5	8.5	21	23.2	42	50
SSMNG-AD18.5/M20(B/G)	AD18.5	M20x1.5	8	24	26.2	44	50
SSMNG-AD21.2/M20(B/G)	AD21.2	M20x1.5	10	27	29.7	48	25
SSMNG-AD28.5/M25(B/G)	AD28.5	M25x1.5	12	34	37.4	55	20
SSMNG-AD34.5/M32(B/G)	AD34.5	M32x1.5	12	40	44	57.5	10
SSMNG-AD42.5/M40(B/G)	AD42.5	M40x1.5	15	48	51.8	63.5	10
SSMNG-AD54.5/M50(B/G)	AD54.5	M50x1.5	15	59	64	63.5	5



## SSNC系列

### 锁紧式软管接头 With cable gland conduit fitting

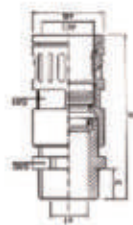

材料: PA6  
温度范围: -40°C-105°C, 短时间可以达到150°C  
防护等级: IP67, 使用合适的密封圈  
Material: PA6  
Temperature Range: Min-40°C, Max105°C, Short-term150°C  
Protection degree: IP66, using suitable seals



#### 德制螺纹 PG Thread

订货编号 Article No.	适配软管 Fit to	螺纹尺寸 φ	卡口范围 Clamping Range	螺纹长度 Thread Length	扳手尺寸 SW	总长 Total Length
SSNC-AD10/P7(B/G)	AD10.0	PG7	3-6.5	8	15	52.0
SSNC-AD13/P9(B/G)	AD13.0	PG9	4-8	8	19	56.0
SSNC-AD15.8/P11(B/G)	AD15.8	PG11	5-10	8	22	58.5
SSNC-AD18.5/P13.5(B/G)	AD18.5	PG13.5	6-12	9	24	61.0
SSNC-AD21.2/P16(B/G)	AD21.2	PG16	10-14	10	27	69.0
SSNC-AD28.5/P21(B/G)	AD28.5	PG21	13-18	11	33	74.0
SSNC-AD34.5/P29(B/G)	AD34.5	PG29	18-25	11	42	85.0
SSNC-AD42.5/P36(B/G)	AD42.5	PG36	22-32	13	52	98.0
SSNC-AD54.5/P42(B/G)	AD54.5	PG42	32-38	15	60	103.0
SSNC-AD54.5/P48(B/G)	AD54.5	PG48	37-44	15	65	103.0

#### 公制螺纹 Metric Thread

订货编号 Article No.	适配软管 Fit to	螺纹尺寸 φ	卡口范围 Clamping Range	螺纹长度 Thread Length	扳手尺寸 SW	总长 Total Length
SSNC-AD10/M12(B/G)	AD10.0	M12x1.5	3-6.5	8	15	52.0
SSNC-AD13/M16(B/G)	AD13.0	M16x1.5	4-8	8	19	56.0
SSNC-AD15.8/M16(B/G)	AD15.8	M16x1.5	5-10	8	22	58.5
SSNC-AD15.8/M18(B/G)	AD15.8	M18x1.5	5-10	8	22	58.5
SSNC-AD18.5/M20(B/G)	AD18.5	M20x1.5	6-12	9	24	61.0
SSNC-AD21.2/M20(B/G)	AD21.2	M20x1.5	10-14	10	27	69.0
SSNC-AD21.2/M22(B/G)	AD21.2	M22x1.5	10-14	10	27	69.0
SSNC-AD21.2/M24(B/G)	AD21.2	M24x1.5	10-14	10	27	69.0
SSNC-AD28.5/PM25(B/G)	AD28.5	M25x1.5	13-18	11	33	74.0
SSNC-AD28.5/PM27(B/G)	AD28.5	M27x2.0	13-18	11	33	74.0
SSNC-AD28.5/PM30(B/G)	AD28.5	M30x2.0	13-18	11	33	74.0
SSNC-AD34.5/M32(B/G)	AD34.5	M32x1.5	18-25	11	42	85.0
SSNC-AD34.5/M36(B/G)	AD34.5	M36x2.0	18-25	11	42	85.0
SSNC-AD42.5/M40(B/G)	AD42.5	M40x1.5	22-32	13	52	98.0
SSNC-AD42.5/M45(B/G)	AD42.5	M45x2.0	22-32	13	52	98.0
SSNC-AD42.5/M48(B/G)	AD42.5	M48x2.0	22-32	13	52	98.0
SSNC-AD54.5/M50(B/G)	AD54.5	M50x1.5	32-38	15	60	103.0
SSNC-AD54.5/M56(B/G)	AD54.5	M56x2.0	32-38	15	60	103.0
SSNC-AD54.5/M63(B/G)	AD54.5	M63x1.5	37-44	15	65	103.0

## SSMNC系列

### 金属锁紧式软管接头 With metal cable gland conduit fitting

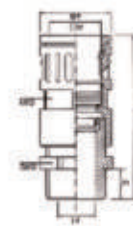

材料: 主体塑料部分为PA6, 金属螺纹部分为黄铜镀镍  
温度范围: -40°C-105°C, 短时间可以达到150°C

Material: The Plastic part is nylon6, the metal part is brass.  
Temperature Range: Min-40°C, Max105°C, Short-term150°C  
Protection degree: IP66, using suitable seals



#### 德制螺纹 PG Thread

订货编号 Article No.	适配软管 Fit to	螺纹尺寸 φ	卡口范围 Clamping Range	螺纹长度 C	扳手尺寸 SW	总长 D
SSMNC-AD10/PG7(B/G)	AD10.0	PG7	3-6.5	5	14	51
SSMNC-AD13/PG9(B/G)	AD13.0	PG9	4-8	6	17	58
SSMNC-AD15.8/PG11(B/G)	AD15.8	PG11	5-10	6	20	59.5
SSMNC-AD18.5/PG13(B/G)	AD18.5	PG13.5	6-12	7	22	63.5
SSMNC-AD21.2/PG16(B/G)	AD21.2	PG16	10-14	7	24	65.5
SSMNC-AD28.5/PG21(B/G)	AD28.5	PG21	13-18	8	30	69.5
SSMNC-AD34.5/PG29(B/G)	AD34.5	PG29	18-25	8	40	81.5
SSMNC-AD42.5/PG36(B/G)	AD42.5	PG36	22-32	9	50	87.5
SSMNC-AD54.5/PG42(B/G)	AD54.5	PG42	32-38	9	60	98.5
SSMNC-AD54.5/PG48(B/G)	AD54.5	PG48	37-44	10	65	99.5

#### 德制螺纹 PG Thread

订货编号 Article No.	适配软管 Fit to	螺纹尺寸 φ	卡口范围 Clamping Range	螺纹长度 C	扳手尺寸 SW	总长 D
SSMNC-AD10/M12(B/G)	AD10.0	M12x1.5	3-6.5	5	14	51
SSMNC-AD13/M16(B/G)	AD13.0	M16x1.5	4-8	5	17	58
SSMNC-AD15.8/M16(B/G)	AD15.8	M16x1.5	5-10	5	20	59.5
SSMNC-AD15.8/M18(B/G)	AD15.8	M18x1.5	5-10	5	20	59.5
SSMNC-AD18.5/M20(B/G)	AD18.5	M20x1.5	6-12	7	22	63.5
SSMNC-AD21.2/M20(B/G)	AD21.2	M20x1.5	10-14	7	24	65.5
SSMNC-AD21.2/M22(B/G)	AD21.2	M22x1.5	10-14	7	24	65.5
SSMNC-AD21.2/M24(B/G)	AD21.2	M24x1.5	10-14	7	27	65.5
SSMNC-AD28.5/M25(B/G)	AD28.5	M25x1.5	13-18	8	30	69.5
SSMNC-AD28.5/M25(B/G)	AD28.5	M27x2.0	13-18	8	30	69.5
SSMNC-AD28.5/M25(B/G)	AD28.5	M30x2.0	13-18	8	34	69.5
SSMNC-AD34.5/M32(B/G)	AD34.5	M32x1.5	18-25	8	40	81.5
SSMNC-AD34.5/M36(B/G)	AD34.5	M36x2	18-25	8	40	81.5
SSMNC-AD42.5/M40(B/G)	AD42.5	M40x1.5	22-32	9	50	87.5
SSMNC-AD42.5/M45(B/G)	AD42.5	M45x2.0	22-32	9	52	87.5
SSMNC-AD42.5/M48(B/G)	AD42.5	M48x2.0	22-32	9	52	87.5
SSMNC-AD54.5/M50(B/G)	AD54.5	M50x1.5	32-38	10	58	98.5
SSMNC-AD54.5/M56(B/G)	AD54.5	M56x2.0	32-38	10	58	98.5
SSMNC-AD54.5/M63(B/G)	AD54.5	M63x1.5	37-44	10	68	99.5



## SSH系列

### 软管固定支架 Conduit Clip



材质: 尼龙6  
温度: -40°C- 105°C  
Material: Nylon 6  
Temperature: -40°C- 105°C

#### SSH带盖软管固定支架

订货编号 Article No.	适配软管规格 Fit to conduit	B mm	H mm	T mm	安装螺丝 mm	A mm	包装数量 Package
黑(B)/灰 (G)							
SSH-AD10 (B/G)	AD10.0	30	23	12.5	M4	7.5	100
SSH-AD13 (B/G)	AD13.0	30	23	12.5	M5	9	100
SSH-AD15.8 (B/G)	AD15.8	30	23	12.5	M5	9	100
SSH-AD18.5 (B/G)	AD18.5	35	30	15	M5	9	100
SSH-AD21.2 (B/G)	AD21.2	35	30	15	M6	11.5	50
SSH-AD25 (B/G)	AD25.0	40	35	16	M6	11.5	50
SSH-AD28.5 (B/G)	AD28.5	42	38	16	M6	11.5	50
SSH-AD34.5 (B/G)	AD34.5	51	43	16	M6	11.5	25
SSH-AD42.5 (B/G)	AD42.5	61	51	16	M6	11.5	25
SSH-AD54.5 (B/G)	AD54.5	74	64	19	M6	11.5	20

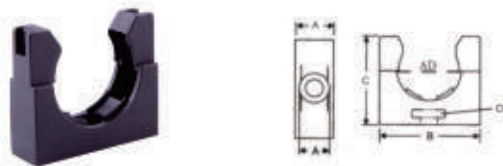

材质: 尼龙6  
温度: -40°C- 105°C  
Material: Nylon 6  
Temperature: -40°C- 105°C

#### SSH不带盖软管固定支架

订货编号 Article No.	适配软管规格 Fit to conduit	B mm	H mm	T mm	安装螺丝 mm	A mm	包装数量 Package
黑(B)/灰 (G)							
SSH-AD10 (B/G)	AD10.0	30	23	12.5	M4	7.5	100
SSH-AD13 (B/G)	AD13.0	30	23	12.5	M5	9	100
SSH-AD15.8 (B/G)	AD15.8	30	23	12.5	M5	9	100
SSH-AD18.5 (B/G)	AD18.5	35	30	15	M5	9	100
SSH-AD21.2 (B/G)	AD21.2	35	30	15	M6	11.5	50
SSH-AD25 (B/G)	AD25.0	40	35	16	M6	11.5	50
SSH-AD28.5 (B/G)	AD28.5	42	38	16	M6	11.5	50
SSH-AD34.5 (B/G)	AD34.5	51	43	16	M6	11.5	25
SSH-AD42.5 (B/G)	AD42.5	61	51	16	M6	11.5	25
SSH-AD54.5 (B/G)	AD54.5	74	64	19	M6	11.5	20

## SSFQ系列

### 防水型软管接头 Waterproof hose connector



产品材质: 主体部分采用尼龙PA66; 密封件部分采用三元乙丙(EPDM)耐候橡胶制成。  
保护等级: IP68  
阻燃等级: UL94-V2, 可以定制UL94-V0。  
工作温度: 静态-40°C至100°C,或瞬间可耐热至120°C;动态-20°C至80°C,或瞬间可耐热至100°C。  
颜色种类: 黑色、灰色, 其它颜色可定做。  
Material: The body PA66; The seals are EPDM.  
IP degree: IP68  
Flame retardant rating: UL94-V2, customizable UL94-V0.  
Temperature Range: Min-40°C, Max105°C, Short-term120°C  
Color: Black, Gray, Other colors can be customized.

#### PG制螺纹 PG THREAD

订货编号 Article No.	适配软管AD Fits to Tubing size	螺纹规格 Thread Dimension	螺纹外径 Thread OD	螺纹长度C Thread Length	包装数量 Package pcs
注: 黑色(B),灰色 (G)					
SSFQ-AD10/P7 (B/G)	10	PG7	12.5	9	50
SSFQ-AD10/P9 (B/G)	10	PG9	15.2	9	50
SSFQ-AD13/P11 (B/G)	13	PG11	18.6	10	50
SSFQ-AD15.8/P13.5 (B/G)	15.8	PG13.5	20.4	10	50
SSFQ-AD18.5/P13.5 (B/G)	18.5	PG13.5	20.4	10	50
SSFQ-AD21.2/P16 (B/G)	21.2	PG16	22.5	13	50
SSFQ-AD25/P21 (B/G)	25	PG21	28.3	13	50
SSFQ-AD28.5/P21 (B/G)	28.5	PG21	28.3	13	50
SSFQ-AD34.5/P29 (B/G)	34.5	PG29	37	13	20
SSFQ-AD42.5/P36 (B/G)	42.5	PG36	47	13	20
SSFQ-AD54.5/P48 (B/G)	54.5	PG48	59.3	16	10

#### 公制螺纹 Metric Thread

订货编号 Article No.	适配软管AD Fits to Tubing size	螺纹规格 Thread Dimension	螺纹外径 Thread OD	螺纹长度C Thread Length	包装数量 Package pcs
注: 黑色(B),灰色 (G)					
SSFQ-AD10/M10 (B/G)	10	M10x1.5	10	9	50
SSFQ-AD10/M12 (B/G)	10	M12x1.5	12	9	50
SSFQ-AD13/M16 (B/G)	13	M16x1.5	16	10	50
SSFQ-AD15.8/M16 (B/G)	15.8	M16x1.5	16	10	50
SSFQ-AD15.8/M20 (B/G)	15.8	M20x1.5	20	10	50
SSFQ-AD18.5/M20 (B/G)	18.5	M20x1.5	20	10	50
SSFQ-AD18.5/M22 (B/G)	18.5	M22x1.5	22	10	50
SSFQ-AD21.2/M20 (B/G)	21.2	M20x1.5	20	13	50
SSFQ-AD21.2/M25 (B/G)	21.2	M25x1.5	25	13	50
SSFQ-AD25/M25 (B/G)	25	M25x1.5	25	13	50
SSFQ-AD28.5/M25 (B/G)	28.5	M25x1.5	25	13	50
SSFQ-AD34.5/M32 (B/G)	34.5	M32x1.5	32	13	20
SSFQ-AD42.5/M40 (B/G)	42.5	M40x1.5	40	13	20
SSFQ-AD54.5/M50 (B/G)	54.5	M50x1.5	50	16	10
SSFQ-AD54.5/M63 (B/G)	54.5	M63x1.5	50	16	10



## SSFQW系列

### 90度防水型软管接头 90° Waterproof hose connector

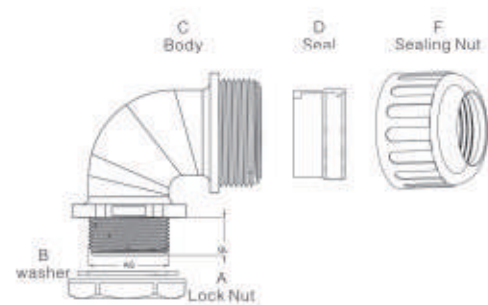

产品材质: 主体部分采用尼龙PA66; 密封件部分采用三元乙丙(EPDM)耐候橡胶制成。  
 保护等级: IP68  
 阻燃等级: UL94-V2, 可以定制UL94-V0。  
 工作温度: 静态-40°C至100°C,或瞬间可耐热至120°C;动态-20°C至80°C,  
 或瞬间可耐热至100°C。  
 颜色种类: 黑色、灰色, 其它颜色可定做。  
 Material: The body PA66; The seals are EPDM.  
 IP degree: IP68  
 Flame retardant rating: UL94-V2, customizable UL94-V0.  
 Temperature Range: Min-40°C, Max105°C, Short-term120°C  
 Color: Black, Gray, Other colors can be customized.

#### PG制螺纹 PG THREAD

订货编号 Articie No	适配软管AD Fits to Tubing size	螺纹规格 Thread Dimension	螺纹外径 Thread OD	螺纹长度C Thread Length	包装数量 Package pcs
注: 黑色(B),灰色 (G)					
SSFQW-AD10/M12 (B/G)	10	M12x1.5	12	9	50
SSFQW-AD13/M16 (B/G)	13	M16x1.5	16	10	50
SSFQW-AD15.8/M16 (B/G)	15.8	M16x1.5	16	10	50
SSFQW-AD15.8/M20 (B/G)	15.8	M20x1.5	20	10	50
SSFQW-AD18.5/M20 (B/G)	18.5	M20x1.5	20	10	50
SSFQW-AD21.2/M20 (B/G)	21.2	M20x1.5	20	15	50
SSFQW-AD25/M25 (B/G)	25	M25x1.5	25	15	50
SSFQW-AD28.5/M25 (B/G)	28.5	M25x1.5	25	15	50
SSFQW-AD34.5/M32 (B/G)	34.5	M32x1.5	32	15	20
SSFQW-AD42.5/M40 (B/G)	42.5	M40x1.5	40	20	20



#### 电缆防水接头系列 Cable Gland Series

塑料篇 Plastic

金属篇 Metal

#### 塑料波纹软管及接头系列 Plastic Flexible Conduit & Fitting

软管接头及附件 Fitting & Accessory

#### ▶ 金属软管及接头 Metal Flexible Conduit & Fitting

塑料工程拖链 Plastic Cable Drag Chain

散热防水透气阀 Breathable Vent Plug

塑料冷却水管 Cooling Tube



## SSSP系列

## 金属包塑软管 PVC Coated Metal Flexible Conduit

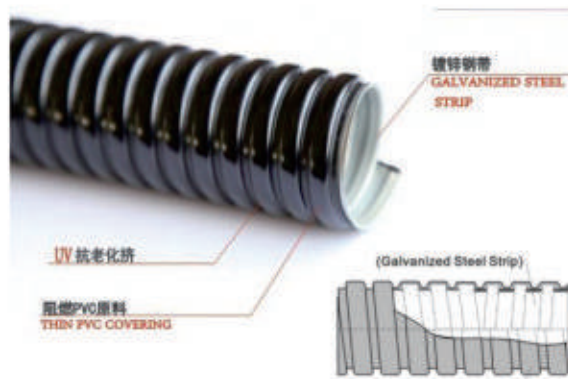

产品材质: (内层) 采用镀锌钢带及特殊绝缘处理; (外层) 采用PVC原料 (抗紫外线、防老化)

产品颜色: 黑色, 灰色

应用领域: 铁路, 机车, 交通系统工程, 空调, 各种机械, 自动化控制设备, 发电厂, 化工, 输配电系统, 通信系统, 船舶, 大厦, 厂房内及屋外露出部分之配线保护。

温度范围: -25°C-80°C, 短时间达到100°C。

Material: (Inner layer) galvanized steel strip and special insulation treatment; (outer layer) using PVC raw material (anti-ultraviolet, anti-aging)

Color: Black/ Gray

Applications: Railways, locomotives, traffic systems engineering, air conditioning, various types of machinery, automatic control equipment, power plants, chemical industry, transmission and distribution systems, communications systems, ships, buildings, wiring protection of exposed parts inside and outside the plant.

Temperature range: -25 °C - 80 °C, short time up to 100 °C.

订货编号	公制规格	英制规格	外径尺寸	弯曲半径	最大轴向拉力KG	包装 M
Article No.	Metric	Inch	OD mm	Bending Radius	Max.axialtension	Packing
SS-SP-6(B/G)	φ6	3/16"	9.0	40	335	200
SS-SP-8(B/G)	φ8	1/4"	11.8	45	470	200
SS-SP-10(B/G)	φ10	5/16"	14.5	55	590	100
SS-SP-12(B/G)	φ12	--	16.5	60	710	100
SS-SP-13(B/G)	φ13	3/8"	17.5	65	765	100
SS-SP-15(B/G)	φ15	--	20.2	80	885	100
SS-SP-16(B/G)	φ16	1/2"	21.2	85	940	100
SS-SP-19(B/G)	φ19	--	24.5	95	1120	50
SS-SP-20(B/G)	φ20	3/4"	25.5	100	1180	50
SS-SP-25(B/G)	φ25	1"	31.7	120	1450	50
SS-SP-32(B/G)	φ32	1, 1/4"	39.6	150	1885	25
SS-SP-38(B/G)	φ38	1, 1/2"	46.6	180	2240	25
SS-SP-51(B/G)	φ51	1, 1/2"	59.5	220	3000	20
SS-SP-64(B/G)	φ64	2, 1/2"	73.5	310	3770	10
SS-SP-75(B/G)	φ75	3"	84.5	350	4400	10
SS-SP-100(B/G)	φ100	4"	109.0	410	4700	10

## SSJS系列

## 金属软管Galvanized Metal Flexible Conduit

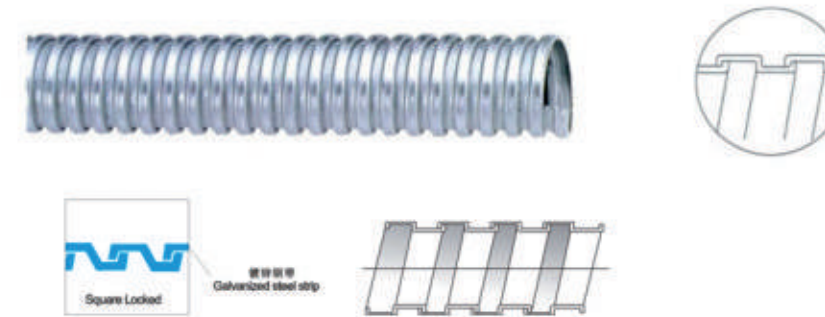

产品材质: 采用镀锌钢带, 国标厚度制作, 具超柔软与极佳弯曲性能, 内部平滑构造在穿引电线时极容易。

应用领域: 机械, 大厦, 厂房内等建筑之配线保护, 保护电线电缆以及达到绝缘, 并可增进线缆弯曲美观。

温度范围: -25°C-80°C, 短时间达到100°C。

Material: Made of galvanized steel strip, made of national standard thickness, with super softness and excellent bending performance, the internal smooth structure is very easy when threading the wire.

Application: Wiring protection of machinery, buildings, factories and other buildings, protection of wire and cable and insulation, and can improve the cable bending appearance.

Temperature range: -25 °C - 80 °C, short time up to 100 °C.

订货编号	公制规格	英制规格	外径尺寸	弯曲半径	最大轴向拉力KG	包装 M
Article No.	Metric	Inch	OD mm	Bending Radius	Max.axialtension	Packing
SS-JS-6(B/G)	φ6	3/16"	8.2	40	335	200
SS-JS-8(B/G)	φ8	1/4"	11.0	45	470	200
SS-JS-10(B/G)	φ10	5/16"	13.5	55	590	100
SS-JS-12(B/G)	φ12	--	15.5	60	710	100
SS-JS-13(B/G)	φ13	3/8"	16.5	65	765	100
SS-JS-15(B/G)	φ15	--	19.0	80	885	100
SS-JS-16(B/G)	φ16	1/2"	20.0	85	940	100
SS-JS-19(B/G)	φ19	--	23.3	95	1120	50
SS-JS-20(B/G)	φ20	3/4"	24.3	100	1180	50
SS-JS-25(B/G)	φ25	1"	30.3	120	1450	50
SS-JS-32(B/G)	φ32	1, 1/4"	38.0	150	1885	25
SS-JS-38(B/G)	φ38	1, 1/2"	45.0	180	2240	25
SS-JS-51(B/G)	φ51	1, 1/2"	58.0	220	3000	20
SS-JS-64(B/G)	φ64	2, 1/2"	72.5	310	3770	10
SS-JS-75(B/G)	φ75	3"	83.5	350	4400	10
SS-JS-100(B/G)	φ100	4"	108.5	410	4700	10



## SSJSP系列

### 平包塑软管 Smooth PVC Coated Metal Conduit

产品材质: (内层) 采用镀锌钢带及特殊绝缘处理;  
(外层) 采用PVC原料 (抗紫外线、防老化)。

产品颜色: 黑色/灰色

产品用途: 保护电线电缆以及达到绝缘、防水。

应用领域: 铁路, 机车, 交通系统工程, 空调, 各种机械, 发电厂, 化工, 输配电系统, 通信系统, 船舶, 大厦, 厂房内及屋外露出部分之配线保护。

温度范围: -25°C-80°C, 短时间达到100°C。

Material: (Inner layer) galvanized steel strip and special insulation treatment; (outer layer) using PVC raw material (anti-ultraviolet, anti-aging)

Color: Black/ Gray

Product use: Protection of wire and cable and insulation, waterproof.

Applications: Railways, locomotives, traffic systems engineering, air conditioning, various types of machinery, power plants, chemicals, power transmission and distribution systems, communications systems, ships, buildings, wiring protection of exposed parts inside and outside the building.

Temperature range: -25 °C -80 °C, short time up to 100 °C.



订货编号	公制规格	英制规格	外径尺寸	弯曲半径	最大轴向拉力KG	包装 M
Article No.	Metric	Inch	OD mm	Bending Radius	Max.axialtension	Packing
SS-JSP-10(B/G)	φ10	5/16"	14.5	55	590	100
SS-JSP-12(B/G)	φ12	--	16.5	60	710	50
SS-JSP-13(B/G)	φ13	3/8"	17.5	65	765	50
SS-JSP-15(B/G)	φ15	--	20.2	80	885	50
SS-JSP-16(B/G)	φ16	1/2"	21.2	85	940	50
SS-JSP-19(B/G)	φ19	--	24.5	95	1120	50
SS-JSP-20(B/G)	φ20	3/4"	25.5	100	1180	50
SS-JSP-25(B/G)	φ25	1"	31.7	120	1450	50
SS-JSP-32(B/G)	φ32	1, 1/4"	39.6	150	1885	20
SS-JSP-38(B/G)	φ38	1, 1/2"	46.6	180	2240	20
SS-JSP-51(B/G)	φ51	1, 1/2"	59.5	220	3000	20
SS-JSP-64(B/G)	φ64	2, 1/2"	73.0	310		10
SS-JSP-75(B/G)	φ75	3"	88.9	350		10
SS-JSP-100(B/G)	φ100	4"	114.3	410		5

## DPJ系列

### DPJ型端接式接头 DPJ Type Liquidtight Connector

材料: 镀锌锌合金; 盖封螺母: 镀铬锌合金

护圈: TPE; 密封垫: 改性橡胶; 软管护口: 镀锌铁皮

温度范围: -40°C至105°C

特点: 一端连接金属软管, 另一端由螺纹连接箱体或设备, 具有结构紧凑, 防水, 耐腐蚀等特点。

Material: Body: galvanized Zinc alloy;

Cover Lock Nut: chromeplated Zinc alloy;

Guarding: TPE; Seal: modified rubber; Ferrule: galvanized steel

Temperature Range: Min-40°C, Max105°C

Specially: One side connect with metal tube, and the other side connect with box or equipments, The structures is compact.



#### 公制螺纹 Metric Thread

订货编号	螺纹尺寸	适配软管	螺纹长度	外圆直径	高度
Article No.	Thread Size	Fit to tube	C mm	Bmm	Amm
DPJ-8-M16	M16x1.5	8	8	25	26
DPJ-10-M16	M16x1.5	10	8	25.6	30
DPJ-12-M20	M16x1.5	12	11.5	28.5	32
DPJ-15-M20	M20x1.5	15	12	33	34.5
DPJ-15-M24	M24x1.5	15	12	33	34.5
DPJ-20-M27	M27x2.0	20	14	39	39.5
DPJ-20-M30	M30x2.0	20	14	39	39.5
DPJ-25-M33	M33x2.0	25	15.5	42.5	42.5
DPJ-25-M36	M36x2.0	25	15.5	42.5	42.5
DPJ-32-M42	M42x2.0	32	17	57.5	46.5
DPJ-32-M48	M48x2.0	32	17	57.5	46.5
DPJ-38-M48	M48x2.0	38	18.5	62	51
DPJ-38-M60	M60x2.0	38	18.5	62	51
DPJ-51-M60	M60x2.0	51	20.5	77.5	57
DPJ-51-M72	M72x2.0	51	20.5	77.5	57
DPJ-64-M76	M76x2.0	64	25	95	66
DPJ-75-M88	M88x2.0	75	26	108.5	68

#### 英制螺纹 G Thread

订货编号	螺纹尺寸	适配软管	螺纹长度	外圆直径	高度
Article No.	Thread Size	Fit to tube	C mm	Bmm	Amm
DPJ-8-G6/15	G6/15"	8	8	25	26
DPJ-10-G1/4	G1/4"	10	8	25.6	30
DPJ-12-G3/8	G3/8"	12	11.5	28.5	32
DPJ-15-G1/2	G1/2"	15	12	33	34.5
DPJ-20-G3/4	G3/4"	20	14	39	39.5
DPJ-25-G1	G1"	25	15.5	42.5	42.5
DPJ-32-G1-1/4	G1-1/4"	32	17	57.5	46.5
DPJ-38-G1-1/2	G1-1/2"	38	18.5	62	51
DPJ-51-G2	G2"	51	20.5	77.5	57
DPJ-64-G2-1/2	G2-1/2"	64	25	95	66
DPJ-75-G3	G3"	75	26	108.5	68



## DKJ系列

### DKJ 卡套式接头DKJ Clamp Type Rigid to Liquidtight



材料: 镀锌锌合金; 盖封螺母: 镀铬锌合金  
护圈: TPE; 密封垫: 改性橡胶; 软管护口: 镀锌铁皮温度范围: -40°C至105°C  
特点: 一端连接金属软管, 另一端连接无螺纹钢管, 具有结构紧凑, 防水, 耐腐蚀等特点。  
Material: Body: galvanized Zinc alloy;  
Cover Lock Nut: chromeplated Zinc alloy; Guarding: TPE;  
Seal: modified rubber; Ferrule: galvanized steel  
Temperature Range: Min-40°C, Max105°C  
Specially: One side connect with metal tube, and the other side connect with steel flat tube, The structures is compact.

订货编号 Article No.	适配软管 d mm	卡套长度 C mm	外圆直径 B mm	高度 Amm
DKJ-10-G1/4	10	8	25.6	30
DKJ-12-G3/8	12	11.5	28.5	32
DKJ-15-G1/2	15	13	33	35
DKJ-20-G3/4	20	15	39	40
DKJ-25-G1	25	16	42.5	40.5
DKJ-32-G1-1/4	32	18	57.5	47
DKJ-38-G1-1/2	38	20	62	49
DKJ-51-G2	51	24	77.5	57
DKJ-64-G2-1/2	64	28	95	70
DKJ-75-G3	75	32	108.5	74

## DPN系列

### DPN 型内螺纹式接头DPN Compression Type Fit for BSP(G)Thread



材料: 镀锌锌合金; 盖封螺母: 镀铬锌合金  
护圈: TPE; 密封垫: 改性橡胶; 软管护口: 镀锌铁皮温度范围: -40°C至105°C  
特点: 一端连接金属软管, 另一端由螺纹连接箱体或设备, 具有结构紧凑, 防水, 耐腐蚀等特点。  
Material: Body: galvanized Zinc alloy;  
Cover Lock Nut: chromeplated Zinc alloy; Guarding: TPE;  
Seal: modified rubber; Ferrule: galvanized steel  
Temperature Range: Min-40°C, Max105°C  
Specially: One side connect with metal tube, and the other side connect with box or equipments, The structures is compact.

订货编号 Article No.	螺纹尺寸 Thread Size	适配软管 d mm	螺纹长度 C mm	外圆直径 B mm	高度 Amm
DPN-12-G3/8	G3/8"	12	11.5	28.5	32
DPN-15-G1/2	G1/2"	15	12	33	35
DPN-20-G3/4	G3/4"	20	12.5	39	38
DPN-25-G1	G1"	25	13	42.5	41
DPN-32-G1-1/4	G1-1/4"	32	14	57.5	44
DPN-38-G1-1/2	G1-1/2"	38	16	62	47
DPN-51-G2	G2"	51	20	77.5	57
DPN-64-G2-1/2	G2-1/2"	64	23	95	65
DPN-75-G3	G3"	75	30	108.5	75

## DGJ系列

### DGJ 型卡簧式接头DGJ Clamp Type Rigid to Liquidtight



材料: 镀锌锌合金; 盖封螺母: 镀铬锌合金  
护圈: TPE; 密封垫: 改性橡胶; 软管护口: 镀锌铁皮温度范围: -40°C至105°C  
特点: 一端连接金属软管, 另一端连接无螺纹钢管, 具有结构紧凑, 防水, 耐腐蚀等特点。  
Material: Body: galvanized Zinc alloy;  
Cover Lock Nut: chromeplated Zinc alloy; Guarding: TPE;  
Seal: modified rubber; Ferrule: galvanized steel  
Temperature Range: Min-40°C, Max105°C  
Specially: One side connect with metal tube, and the other side connect with steel flat tube, The structures is compact.

订货编号 Article No.	适配软管 d mm	外圆直径 B mm	高度 Amm
DGJ-10-G1/4	10	25.6	38
DGJ-12-G3/8	12	28.5	40
DGJ-15-G1/2	15	33	43
DGJ-20-G3/4	20	39	47
DGJ-25-G1	25	42.5	48
DGJ-32-G1-1/4	32	57.5	54
DGJ-38-G1-1/2	38	62	56
DGJ-51-G2	51	77.5	65
DGJ-64-G2-1/2	64	95	82
DGJ-75-G3	75	108.5	85

## DWJ系列

### DWJ型90°弯接头DWJ Type Liquidtight Connector



材料: 镀锌锌合金; 盖封螺母: 镀铬锌合金  
护圈: TPE; 密封垫: 改性橡胶; 软管护口: 镀锌铁皮温度范围: -40°C至105°C  
特点: 一端连接金属软管, 另一端由螺纹连接箱体或设备, 具有结构紧凑, 防水, 耐腐蚀等特点。  
Material: Body: galvanized Zinc alloy;  
Cover Lock Nut: chromeplated Zinc alloy; Guarding: TPE;  
Seal: modified rubber; Ferrule: galvanized steel  
Temperature Range: Min-40°C, Max105°C  
Specially: One side connect with metal tube, and the other side connect with box or equipments, The structures is compact.

订货编号 Article No.	螺纹尺寸 Thread Size	适配软管 d mm	螺纹长度 C mm	外圆直径 B mm	高度 Amm
DWJ-12-G3/8	G3/8"	12	11.5	28	19
DWJ-15-G1/2	G1/2"	15	11.5	32.5	21
DWJ-20-G3/4	G3/4"	20	15	39	27
DWJ-25-G1	G1"	25	16	46.5	30
DWJ-32-G1-1/4	G1-1/4"	32	17	56.5	35
DWJ-38-G1-1/2	G1-1/2"	38	18	64	40
DWJ-51-G2	G2"	51	20	78	46
DWJ-64-G2-1/2	G2-1/2"	64	26	97	61
DWJ-75-G3	G3"	75	28	115	70



## DWJ系列

### DWJ 型45°弯接头 DWJ 45Degree Liquidtight Connector



材料: 镀锌锌合金; 盖封螺母: 镀铬锌合金  
 护圈:TPE; 密封垫: 改性橡胶; 软管护口: 镀锌铁皮温度范围: -40°C至105°C  
 特点: 一端连接金属软管, 另一端由螺纹连接箱体或设备, 具有结构紧凑, 防水, 耐腐蚀等特点。  
 Material: Body: galvanized Zinc alloy;  
 Cover Lock Nut: chromeplated Zinc alloy; Guarding: TPE;  
 Seal: modified rubber; Ferrule: galvanized steel  
 Temperature Range: Min-40°C, Max105°C  
 Specially: One side connect with metal tube, and the other side connect with box or equipments, The structures is compact.

订货编号 Article No.	螺纹尺寸 Thread Size	适配软管 d mm	螺纹长度 C mm	外圆直径 B mm	高度 Amm
DWJ-12-G3/8	G3/8"	12	11.5	28	25
DWJ-15-G1/2	G1/2"	15	11.5	32.5	31
DWJ-20-G3/4	G3/4"	20	15	39	40
DWJ-25-G1	G1"	25	16	46.5	47
DWJ-32-G1-1/4	G1-1/4"	32	17	56.5	52
DWJ-38-G1-1/2	G1-1/2"	38	18	64	62
DWJ-51-G2	G2"	51	20	78	75
DWJ-64-G2-1/2	G2-1/2"	64	26	97	90
DWJ-75-G3	G3"	75	28	115	105

## DPY系列

### Y型三通接头 DPY Y type Liquid tight Connector



产品材质: 主体部分为锌合金, 密封圈为丁腈橡胶, 软管护口部分为镀锌铁皮  
 温度范围: -40°C-105°C  
 防护等级: IP66  
 Material: The main part is zinc alloy, the sealing ring is nitrile rubber, and the hose protection part is galvanized iron sheet  
 Temperature range: -40°C-105°C  
 IP Degree: IP66

订货编号 Article No.	适配软管 d mm	订货编号 Article No.	适配软管 d mm
DPY-121212	φ12/φ12/φ12	DPY-152532	φ15/φ25/φ32
DPY-121215	φ12/φ12/φ15	DPY-202020	φ20/φ20/φ20
DPY-121515	φ12/φ15/φ15	DPY-202025	φ20/φ20/φ25
DPY-121520	φ12/φ15/φ20	DPY-202532	φ20/φ25/φ32
DPY-151515	φ15/φ15/φ15	DPY-252525	φ25/φ25/φ25
DPY-151520	φ15/φ15/φ20	DPY-252532	φ25/φ25/φ32
DPY-151525	φ15/φ15/φ25	DPY-253232	φ25/φ32/φ32
DPY-152025	φ15/φ20/φ25	DPY-253238	φ25/φ32/φ38
DPY-152525	φ15/φ25/φ25	DPY-253838	φ25/φ38/φ38

## SSCF系列

### 黄铜镀镍固定式接头 Brass Plated Nickel fixed fitting



产品材质: 黄铜镀镍  
 Material: Brass  
 特点: 一端连接金属软管, 另一端由螺纹连接箱体或设备, 耐高温, 耐腐蚀, 抗冲击力强等。  
 Features: One end is connected to a metal hose, and the other end is connected to a box or device by thread. High temperature resistance, corrosion resistance, impact resistance and so on.

#### 公制螺纹 Metric Thread

订货编号 Article No.	适配软管 d mm	螺纹规格 Thread	扳手尺寸 Wrench	螺纹长度 Thread Length	总长 Total Length
SS-CF10	φ8	M12x1.5	14	8	26
SS-CF12	φ12	M16x1.5	17	10	28.5
SS-CF16	φ15	M20x1.5	21	10	30
SS-CF20	φ20	M20x1.5	24	10	30
SS-CF25	φ25	M25x1.5	28	10	32.5
SS-CF32	φ32	M32x1.5	38	11	40
SS-CF40	φ38	M49x1.5	48	12	40
SS-CF50	φ51	M50x1.5	58	15	46.5

## SSCFS系列

### 黄铜镀镍旋转式接头 Brass Plated Nickel Swivel fitting



产品材质: 黄铜镀镍  
 Material: Brass  
 特点: 一端连接金属软管, 另一端由螺纹连接箱体或设备, 接头可灵活旋转, 耐高温, 耐腐蚀, 抗冲击力强等。  
 Features: One end is connected to a metal hose, and the other end is connected to a box or device by thread. The fitting can be swivel flexibly. High temperature resistance, corrosion resistance, impact resistance and so on.

#### 公制螺纹 Metric Thread

订货编号 Article No.	适配软管 d mm	螺纹规格 Thread	扳手尺寸 Wrench	螺纹长度 Thread Length	总长 Total Length
SS-CF10s	φ8	M12x1.5	14	8	28.5
SS-CF12s	φ12	M16x1.5	17	10	32.5
SS-CF16s	φ15	M20x1.5	21	10	33.5
SS-CF20s	φ20	M20x1.5	24	10	34
SS-CF25s	φ25	M25x1.5	28	10	37
SS-CF32s	φ32	M32x1.5	38	11	40
SS-CF40s	φ38	M49x1.5	48	12	44.5
SS-CF50s	φ51	M50x1.5	58	15	50.5



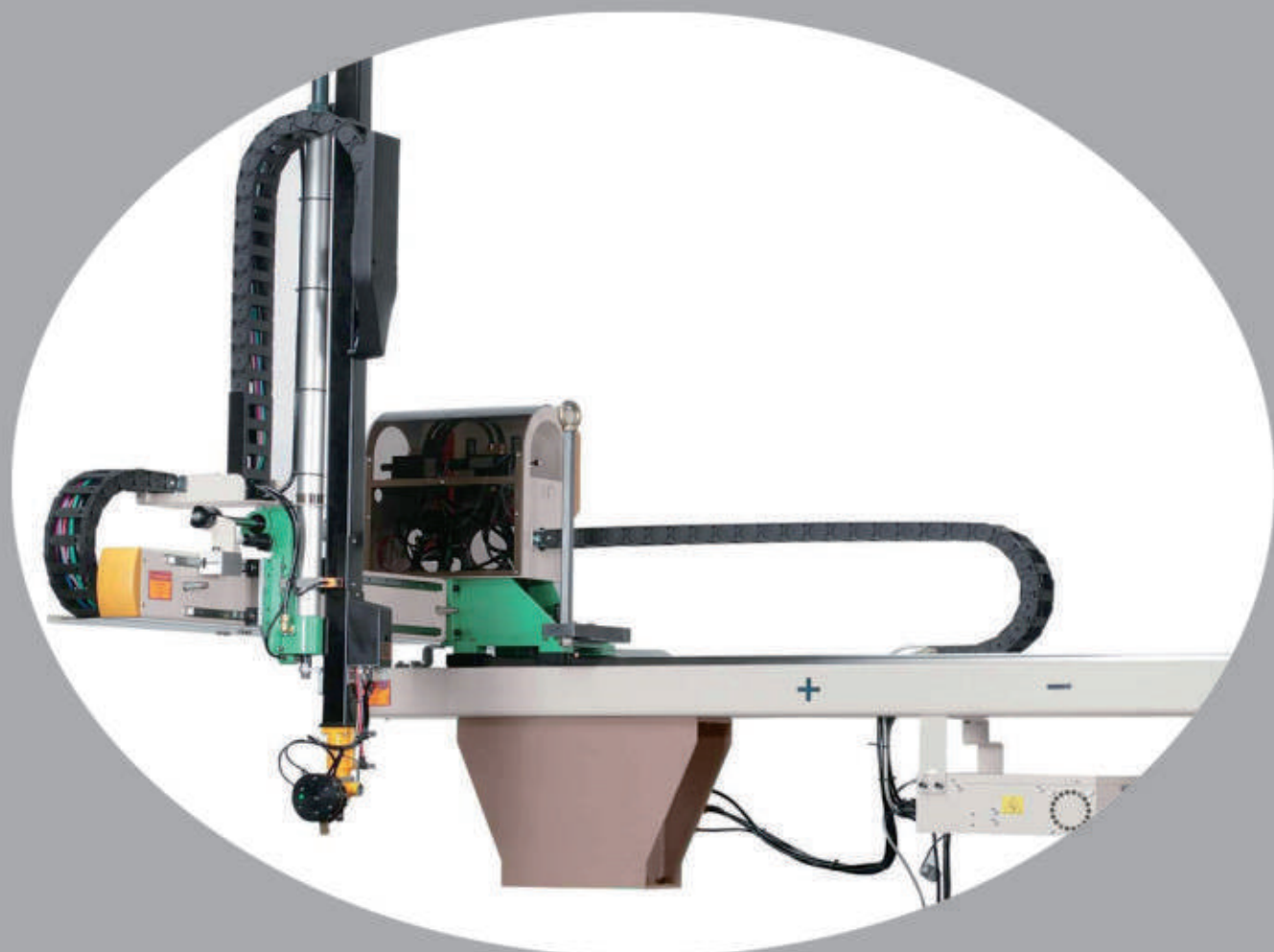

### 电缆防水接头系列 Cable Gland Series

塑料篇 Plastic

金属篇 Metal

### 塑料波纹软管及接头系列 Plastic Flexible Conduit & Fitting

软管接头及配件 Fitting & Accessory

### 金属软管及接头 Metal Flexible Conduit & Fitting

### ▶ 塑料工程拖链 Plastic Cable Drag Chain

散热防水透气阀 Breathable Vent Plug

塑料冷却水管 Cooling Tube

## SUD系列

### SUD-10系列桥式拖链 (整体型) SUD-10 Integrated Cable Chain



#### 应用领域

整体型小型拖链轻便灵活, 广泛应用于工业设备自动化、医疗、自动门机等领域。

The SUD-10 series cable chain are lightweight and flexible, and are widely used in industrial equipment automation, medical, automatic door cranes and other fields.

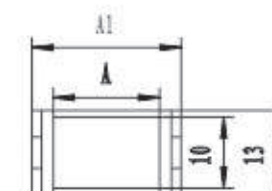
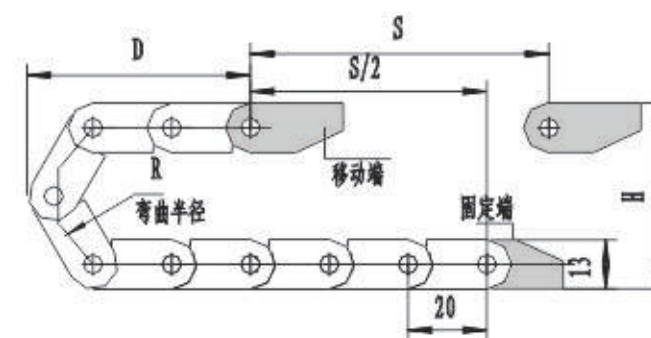

内高B: 10mm  
内宽A: 10-30mm  
节距: 20mm  
每米节数: 50节

订货编号 Order No.	内宽 A	外宽 A <sub>i</sub>	内高 B	外高 B <sub>i</sub>	节距 Pitch	弯曲半径 Bending Radius
SUD1030	30	37	8	13	22	18 30 48
SUD1010	10	17	10			18
SUD1015	15	23				

#### 联接器参数 The end brackets size

订货编号 Order No.	A	B	C	D
SUD1030 E	15	37	23.5	19.5
SUD1010 E		18		
SUD1015 E		23		
SUD10151 E		23	22.5	22.5

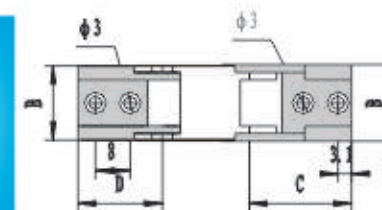

塑料工程拖链  
Plastic Cable Drag Chain

SUD-10系列桥式拖链 (整体型)  
SUD-10 Integrated Cable Chain







## SUD系列

## SUD-25系列桥式拖链 (半封闭和全封闭)

## SUD-25 Bridge Cable Chain (Semi-Enclosed and Totally Enclosed)



## 应用领域

SUD25系列桥式拖链有开放式和全封闭式，广泛应用于工业设备自动化、数控机床、木工机械等领域。

SUD25 Energy chains are available in open and fully enclosed types, and are widely used in industrial equipment automation, CNC machine tools, woodworking machinery and other fields.

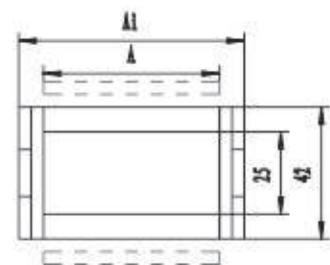
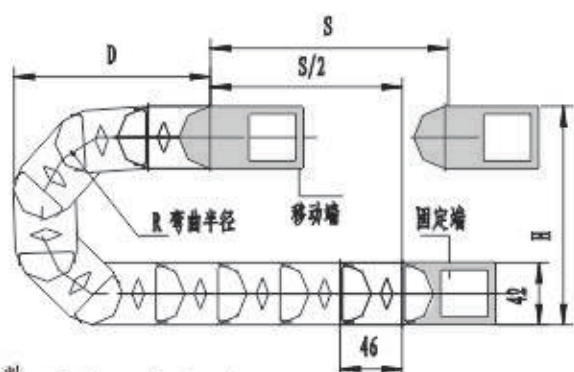

内高B: 25mm  
内宽A: 38-125mm  
节距: 46mm  
每米节数: 21节

## 主要参数 Data of sheet

订货编号 Order No.	内宽 A	外宽 Ai	内高 B	外高 Bi	节距 Pitch	弯曲半径 Bending Radius
SUD2538A	SUD2538B	38	58	25	42	46
SUD2550A	SUD2550B	50	70			
SUD2575A	SUD2575B	75	95			
SUD25100A	SUD25100B	100	120			
SUD25125A	SUD25125B	125	145			

Remark: "A" is Semi-Enclosed  
"B" is Totally Enclosed



## 联接器参数 The end brackets size

订货编号 Order No.	A	B
SUD2538E	53	58
SUD2550E	65	75
SUD2575E	90	100
SUD25100E	115	125
SUD25125E	140	150

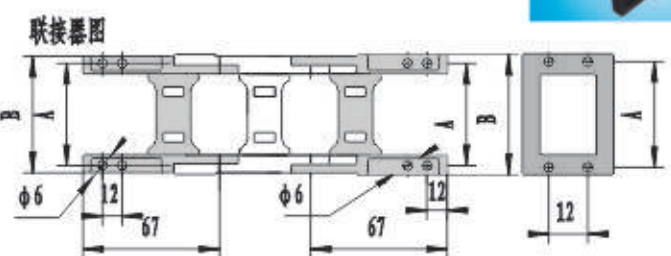

## SUD系列

## SUD-35系列桥式拖链 (半封闭和全封闭)

## SUD-35 Bridge Cable Chain (Semi-Enclosed and Totally Enclosed)



## 应用领域

SUD35系列桥式拖链有开放式和全封闭式，广泛应用于工业设备自动化、数控机床、木工机械等领域。

SUD35 Energy chains are available in open and fully enclosed types, and are widely used in industrial equipment automation, CNC machine tools, woodworking machinery and other fields.

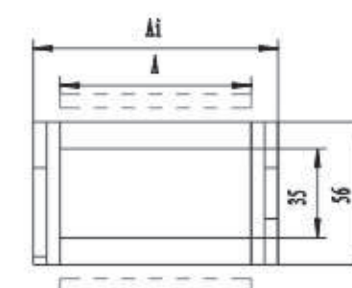
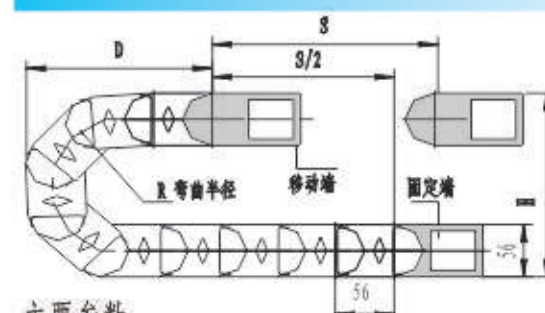

内高B: 35mm  
内宽A: 50-125mm  
节距: 56mm  
每米节数: 17节

## 主要参数 Data of sheet

订货编号 Order No.	内宽 A	外宽 Ai	内高 B	外高 Bi	节距 Pitch	弯曲半径 Bending Radius
SUD3550A	SUD3550B	50	74	35	56	60 100 125 150 200
SUD3560A	SUD3560B	60	84			
SUD3575A	SUD3575B	75	99			
SUD35100A	SUD35100B	100	124			
SUD35125A	SUD35125B	125	149			

Remark: "A" is Semi-Enclosed  
"B" is Totally Enclosed

## 联接器参数 The end brackets size

订货编号 Order No.	A	B
SUD3550E	65	74
SUD3560E	75	84
SUD3575E	90	99
SUD35100E	115	124
SUD35125E	140	150

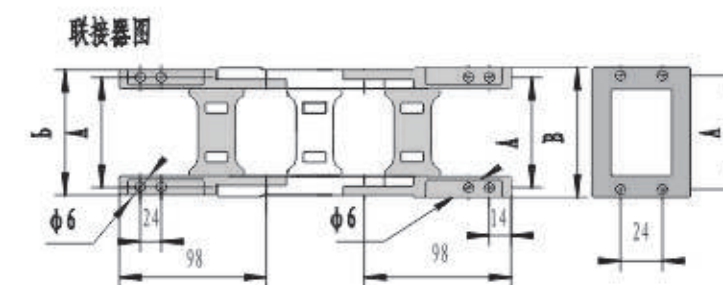



## SUD系列

## SUD-45系列桥式拖链 (半封闭和全封闭)

## SUD-45 Bridge Cable Chain (Semi-Enclosed and Totally Enclosed)

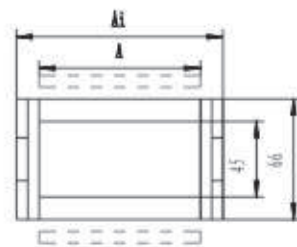
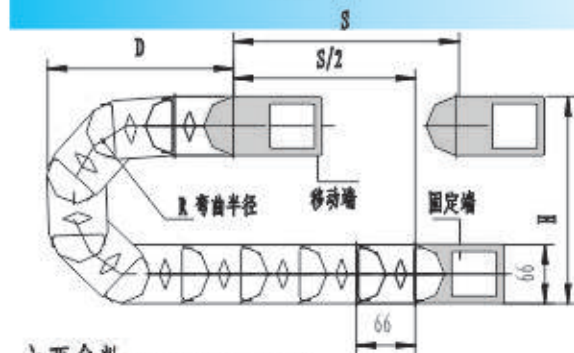
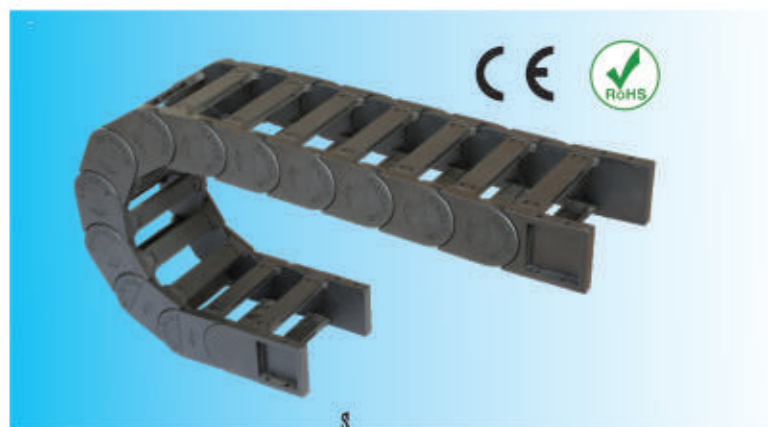

内高B: 45mm  
内宽A: 50-150mm  
节距: 66mm  
每米节数: 15节

## 应用领域

SUD45系列桥式拖链有开放式和全封闭式, 广泛应用于工业设备自动化、数控机床、木工机械等领域。

SUD45 Energy chains are available in open and fully enclosed types, and are widely used in industrial equipment automation, CNC machine tools, woodworking machinery and other fields.

## 主要参数 Data of sheet

订货编号 Order No.	内宽 A	外宽 Ai	内高 B	外高 Bi	节距 Pitch	弯曲半径 Bending Radius
SUD4550A	SUD4550B	50	77	45	66	75 90 100 125 200
SUD4575A	SUD4575B	75	102			
SUD45100A	SUD45100B	100	127			
SUD45125A	SUD45125B	125	152			
SUD45150A		150	177			

Remark: "A" is Semi-Enclosed  
"B" is Totally Enclosed



## 联接器图

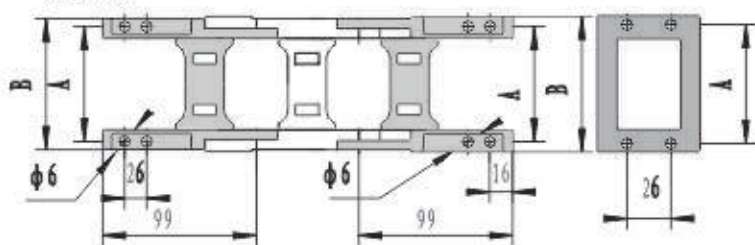

## 联接器参数 The end brackets size

订货编号 Order No.	A	B
SUD4550E	63	77
SUD4575E	88	102
SUD4580E	93	107
SUD45100E	113	127
SUD45115E	128	142
SUD45125E	135	152
SUD45150E	163	177
SUD45200E	213	227

## SUD系列

## SUD-45系列全封闭拖链

## SUD-45 Totally Enclosed Cable Chain



## 安装尺寸 Size:

节距=36毫米 每米节数=28 S=行程距离  
Pitch: 36mm 28 segments/m S=distance

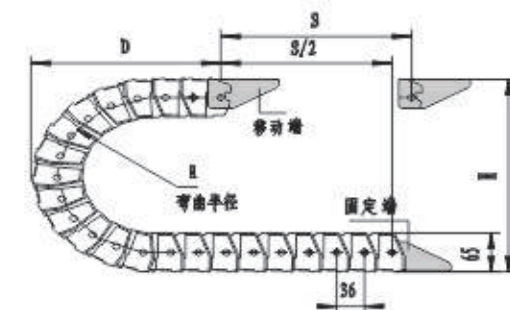

## 主要参数 Data of sheet

订货编号 Order No.	内宽 A	外宽 Ai	内高 B	外高 Bi	节距 Pitch	弯曲半径 Bending Radius
SUDT45075	75	92	45	65	36	130 170
SUDT450116	116	133				

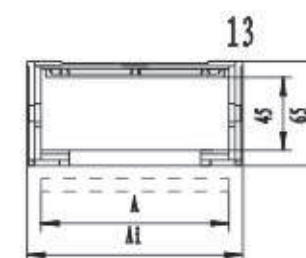

## 金属联接器图

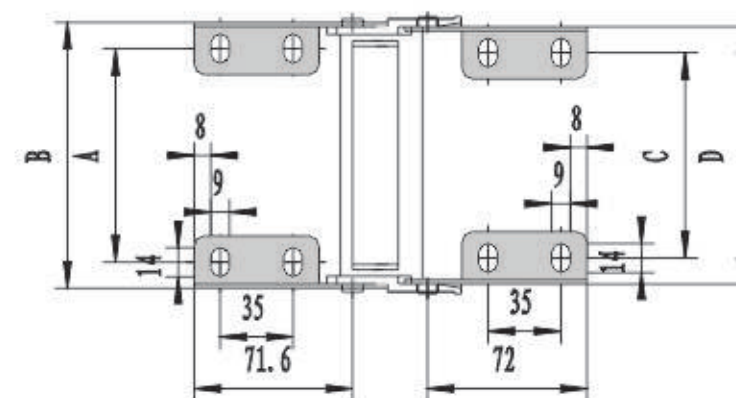

## 联接器参数 The end brackets size

订货编号 Order No.	A	B	C	D
SUDT4575E	61	86	57	82
SUDT45116E	102	127	98	123



## SUD系列

## SUD-56系列桥式拖链 (半封闭和全封闭)

## SUD-56 Bridge Cable Chain (Semi-Enclosed and Totally Enclosed)



## 应用领域

SUD56系列桥式拖链有开放式和全封闭式, 广泛应用于中大型工业设备、数控机床、木工机械等领域。

SUD56Energy chains are available in open and fully enclosed types, and are widely used in industrial equipment automation, CNC machine tools, woodworking machinery and other fields.

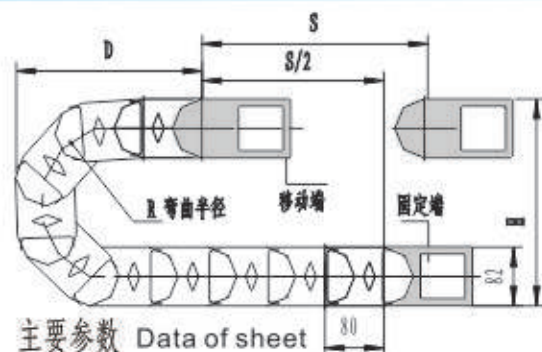

主要参数 Data of sheet

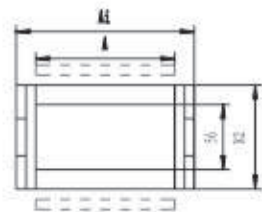

内高B: 56mm  
内宽A: 75-300mm  
节距: 80mm  
每米节数: 13节

订货编号 Order No.	内宽 A	外宽 Ai	内高 B	外高 Bi	节距 Pitch	弯曲半 Bending Radius
SUD5675A	75	105	56	82	80	125 1 200 2
SUD56100A	100	130				
SUD56125A	125	155				
SUD56150A	150	180				
SUD56200A	200	230				
SUD56250A	250	280				
SUD56300A	300	330				

Remark: "A" is Semi-Enclosed  
"B" is Totally Enclosed



联接器图

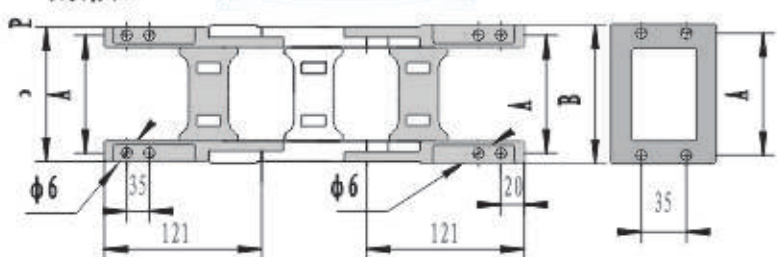

## 联接器参数 The end brackets size

订货编号 Order No.	A	B
SUD5675E	92	105
SUD56100E	117	130
SUD56125E	142	155
SUD56150E	167	180
SUD56200E	217	230
SUD56250E	267	280
SUD56300E	317	330

## SUD系列

## SUD-60系列桥式拖链 (半封闭和全封闭)

## SUD-60 Bridge Cable Chain (Semi-Enclosed and Totally Enclosed)

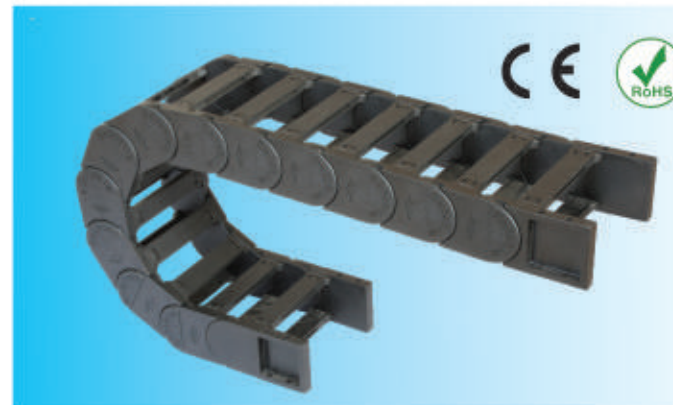

## 应用领域

SUD60系列桥式拖链有开放式和全封闭式, 广泛应用于中大型工业设备、数控机床、木工机械等领域。

SUD60Energy chains are available in open and fully enclosed types, and are widely used in industrial equipment automation, CNC machine tools, woodworking machinery and other fields.

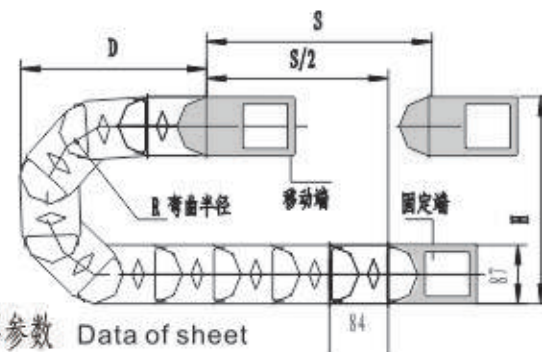

主要参数 Data of sheet

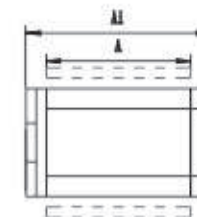

内高B: 60mm  
内宽A: 75-300mm  
节距: 84mm  
每米节数: 12节

订货编号 Order No.	内宽 A	外宽 Ai	内高 B	外高 Bi	节距 Pitch	弯曲半径 Bending Radius
SUD6075A	75	107	60	87	84	150 200 250 300
SUD60100A	100	132				
SUD60125A	125	157				
SUD60150A	150	182				
SUD60200A	200	232				
SUD60250A	250	282				
SUD60300A	300	332				

Remark: "A" is Semi-Enclosed  
"B" is Totally Enclosed



## 联接器参数 The end brackets size

订货编号 Order No.	A	B
SUD6075	94	107
SUD60100	119	132
SUD60125	144	157
SUD60150	169	182
SUD60200	219	232
SUD60250	269	282
SUD60300	319	332

联接器图

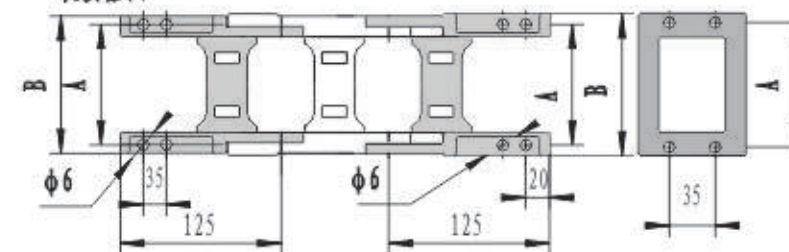



## SUD系列

### SUD-80系列桥式拖链 (半封闭和全封闭)

### SUD-80 Bridge Cable Chain (Semi-Enclosed and Totally Enclosed)

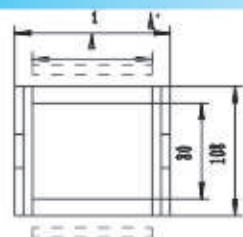

内高B: 80mm  
内宽A: 75-300mm  
节距: 93mm  
每米节数: 10节

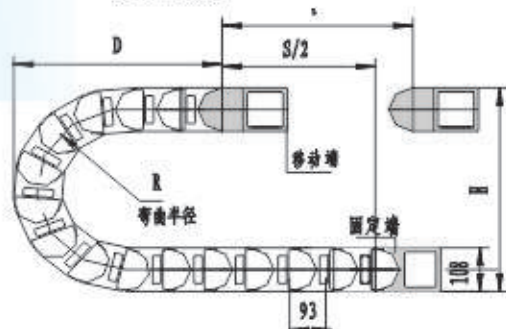

#### 应用领域

SUD80系列桥式拖链有开放式和全封闭式, 广泛应用于中大型工业设备、数控机床、木工机械等领域。

SUD80 Energy chains are available in open and fully enclosed types, and are widely used in industrial equipment automation, CNC machine tools, woodworking machinery and other fields.

订货编号 Order No.	内宽 A	外宽 Ai	内高 B	外高 Bi	节距 Pitch	弯曲半径 Bending Radius
SUD8075A	75	106	80	108	93	150 200
SUD80100A	100	131				
SUD80125A	125	156				
SUD80150A	150	181				
SUD80200A	200	231				
SUD80250A	250	281				
SUD80300A	300	331				

Remark: "A" is Semi-Enclosed  
"B" is Totally Enclosed



连接器图

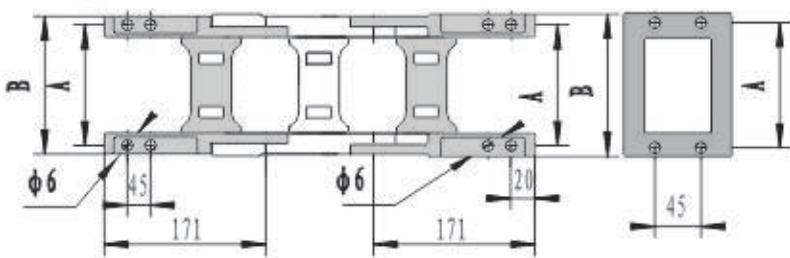

#### 连接器参数 The end brackets size

型号	参数	A	B
SUD8075		92	106
SUD80100		117	131
SUD80125		142	156
SUD80150		167	181
SUD80200		217	231
SUD80250		267	281
SUD80300		317	331

## SU系列

### SU-18系列桥式拖链 (半封闭和全封闭)

### SU-18 Bridge Cable Chain (Semi-Enclosed and Totally Enclosed)

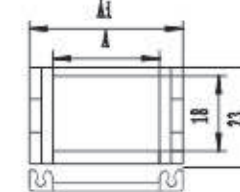
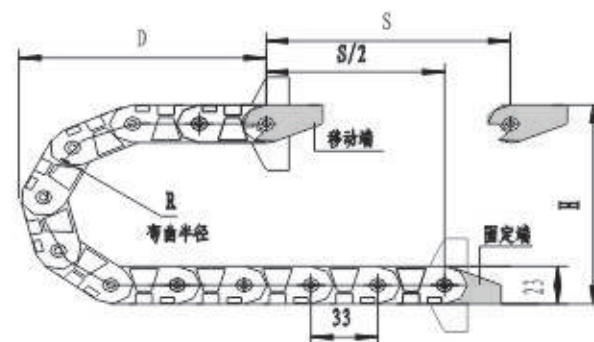

内高B: 18mm  
内宽A: 25-48mm  
节距: 33mm  
每米节数: 30节

#### 应用领域

SU25系列桥式拖链, 灵活轻便, 广泛应用于自动化设备、打印设备、医疗等领域。

The Su25 series cable chain is flexible and lightweight, widely used in Automation equipment, printing equipment, medical and other fields.

#### 主要参数 Data of sheet

订货编号 Order No.	内宽 A	外宽 Ai	内高 B	外高 Bi	节距 Pitch	弯曲半径 Bending Radius
SU1825A	25	36	18	23	33	38 50 60 75 100
SU1838A	38	49				50 75 100
SU1848A	48	59				

Remark: "A" is Semi-Enclosed  
"B" is Totally Enclosed

#### 连接器参数 The end brackets size

订货编号 Order No.	A	B	C
SU1825E	20	30	36
SU1838E	23	44	50
SU1848E	27	54	60

SU1825E  
连接器图

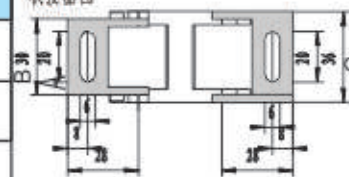

SU1838E  
SU1848E





## SU系列

### SU-21系列桥式拖链

#### SU-21 Bridge Cable Chain



#### 应用领域

Su21系列嵌入式拖链，灵活轻便，广泛应用于自动化设备、打印设备、医疗等领域。

The SU21 series cable chain is flexible and lightweight, widely used in Automation equipment, printing equipment, medical and other fields.

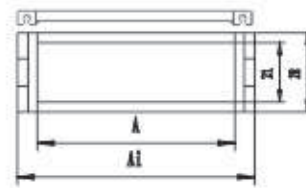
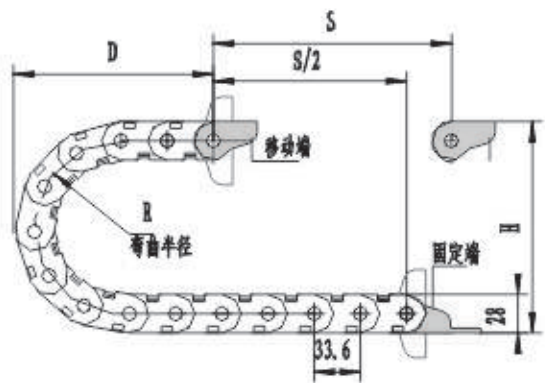

内高B: 21mm  
 内宽A: 70mm  
 节距: 33.6mm  
 每米节数: 30节

#### 主要参数 Data of sheet

订货编号 Order No.	内宽 A	外宽 Ai	内高 B	外高 Bi	节距 Pitch	弯曲半径 Bending Radius
SU2170	70	80	21	28	33.6	75 100 110 125

#### 联接器图

订货编号 Order No.
SU2170E

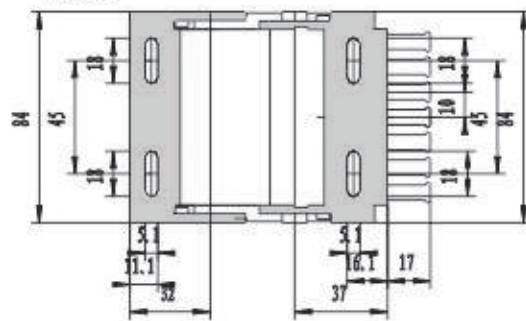

## SU系列

### SU-25系列桥式拖链 (半封闭和全封闭)

#### SU-25 Bridge Cable Chain (Semi-Enclosed and Totally Enclosed)

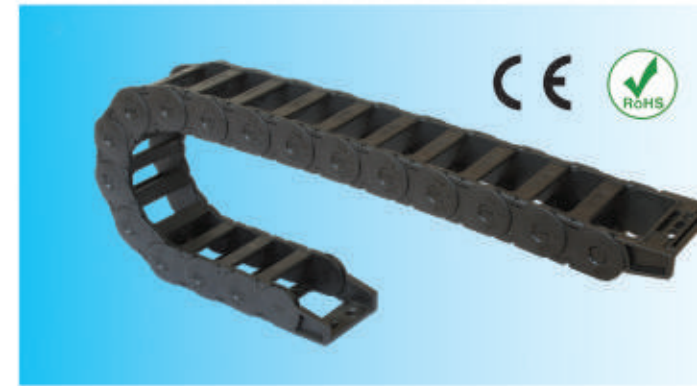

#### 应用领域

Su25系列桥式拖链，灵活轻便，广泛应用于自动化设备、打印设备、医疗等领域。

The Su25 series cable chain is flexible and lightweight, widely used in Automation equipment, printing equipment, medical and other fields.

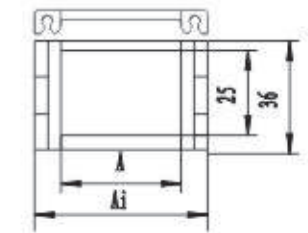
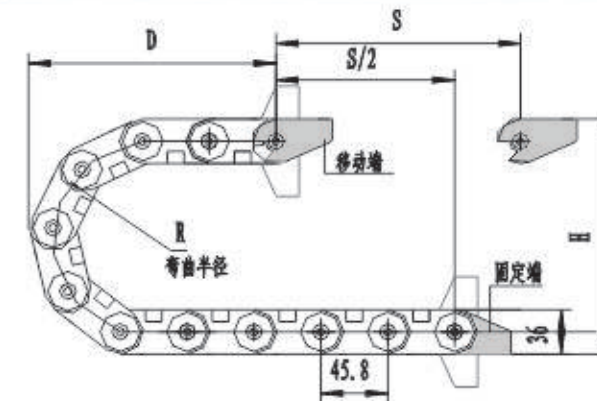

内高B: 251mm  
 内宽A: 25-77mm  
 节距: 46mm  
 每米节数: 21节

#### 主要参数 Data of sheet

订货编号 Order No.	内宽 A	外宽 Ai	内高 B	外高 Bi	节距 Pitch	弯曲半径 Bending Radius
SU2525A	25	43	25	36	45.8	50 55 60 75
SU2538A	38	56				100 125 150 200
SU2557A	57	75				75 90 100
SU2577A	77	95				125 250

Remark: "A" is Semi-Enclosed  
 "B" is Totally Enclosed

#### 联接器参数 The end brackets size

订货编号 Order No.	A	B	C	D
SU2525E	11	36	41	10
SU2538E	24	49	54	10
SU2557E	35	68	73	18
SU2577E	49	88	93	18

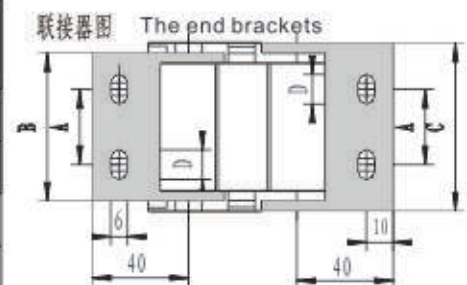



## SU系列

## SU-28系列桥式拖链 (半封闭和全封闭)

## SU-28 Bridge Cable Chain (Semi-Enclosed and Totally Enclosed)



## 应用领域

Su28系列桥式拖链, 灵活轻便, 广泛应用于

自动化设备、打印设备、医疗等领域。

The Su28 series cable chain is flexible and lightweight, widely used in Automation equipment, printing equipment, medical and other fields.

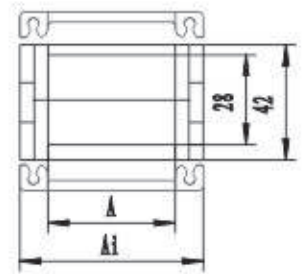
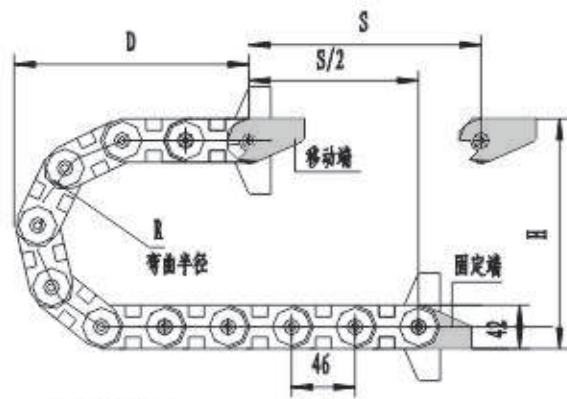

内高B: 28mm  
内宽A: 50-77mm  
节距: 46mm  
每米节数: 22节

## 主要参数 Data of sheet

订货编号 Order No.	内宽 A	外宽 Ai	内高 B	外高 Bi	节距 Pitch	弯曲半径 Bending Radius
SU2850 A	SU2850 B	50	70	28	46	50 75 100 125
SU2860 A	SU2860 B	60	80			
SU2877 A		77	97			

Remark: "A" is Semi-Enclosed  
"B" is Totally Enclosed

## 连接器参数 The end brackets size

订货编号 Order No.	A	B	C
SU2850 E	30	61	67
SU2860 E	40	71	77
SU2877 E	49	88	93

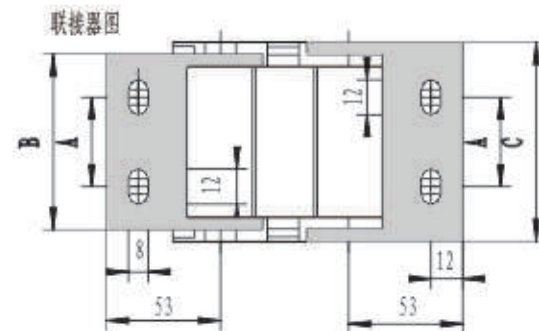

## SU系列

## SU-35系列桥式拖链 (半封闭和全封闭)

## SU-35 Bridge Cable Chain (Semi-Enclosed and Totally Enclosed)



## 应用领域

Su35系列桥式拖链, 灵活轻便, 广泛应用于

自动化设备、打印设备、医疗等领域。

The Su35 series cable chain is flexible and lightweight, widely used in Automation equipment, printing equipment, medical and other fields.

Pitch: 56mm 18 segments/m S=distance

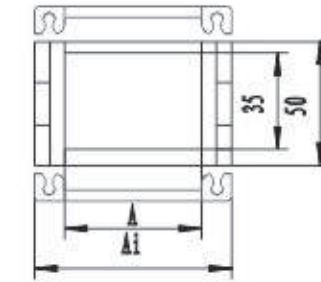
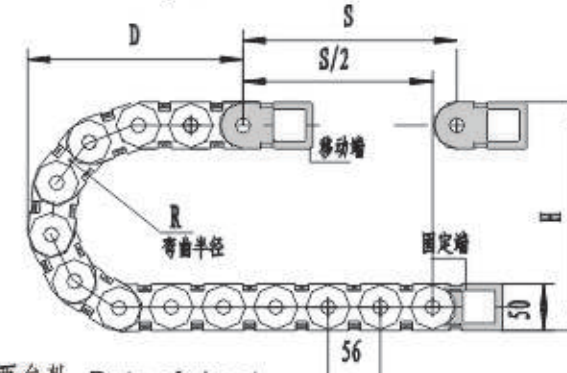

内高B: 35mm  
内宽A: 50-125mm  
节距: 56mm  
每米节数: 18节

## 主要参数 Data of sheet

订货编号 Order No.	内宽 A	外宽 Ai	内高 B	外高 Bi	节距 Pitch	弯曲半径 Bending Radius
SU3550 A	SU3575 B	50	69	35	56	100 125 150 200
SU3575 A		75	94			
SU35100 A		100	119			
SU35125 A		125	144			

Remark: "A" is Semi-Enclosed  
"B" is Totally Enclosed

## 连接器参数 The end brackets size

订货编号 Order No.	A	B
SU3550 E	81	69
SU3575 E	100	94
SU35100 E	131	119
SU35125 E	151	144

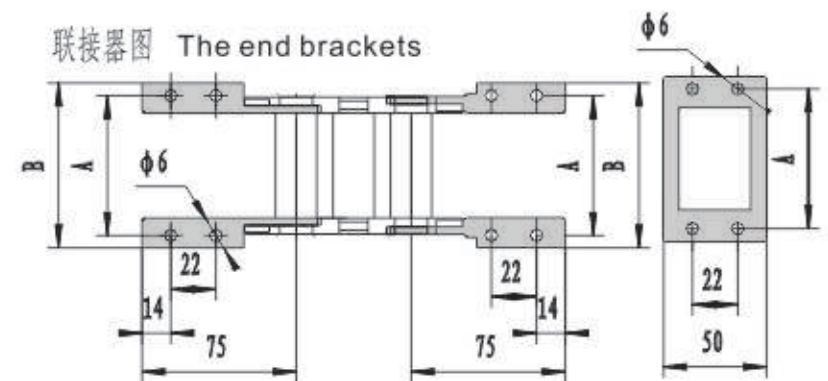





电缆防水接头系列 Cable Gland Series

塑料篇 Plastic

金属篇 Metal

塑料波纹软管及接头系列 Plastic Flexible Conduit & Fitting

软管接头及配件 Fitting & Accessory

金属软管及接头 Metal Flexible Conduit & Fitting

塑料工程拖链 Plastic Cable Drag Chain

► 散热防水透气阀 Breathable Vent Plug

塑料冷却水管 Cooling Tube

# Breathable Vent Plug 散热防水透气系列

## 防水透气膜的工作原理

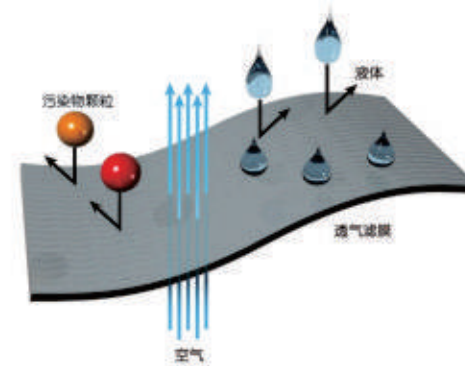

防水透气膜以透气的憎水性膨体聚四氟乙烯 (ePTFE) 为材料, 并通过专利技术处理, 使得薄膜可兼具憎油属性, 从而大大提升透气膜的耐久性。即便长期暴露于户外和工业环境中, 反复接触油、化学品、清洁剂和其它低表面张力液体, 防水防尘透气膜的优异性能始终保持不变。

Waterproof breathable membrane working principle Waterproof and breathable membranes are made of breathable hydrophobic polytetrafluoroethylene (ePTFE) and treated with patented technology, which makes the film have the property of oleophobic, which greatly improves the durability of the breathable film. Even after prolonged exposure to outdoor and industrial environments, repeated exposure to oils, chemicals, detergents, and other low surface tension liquids, the superior performance of waterproof, dust proof, breathable membranes remains the same.

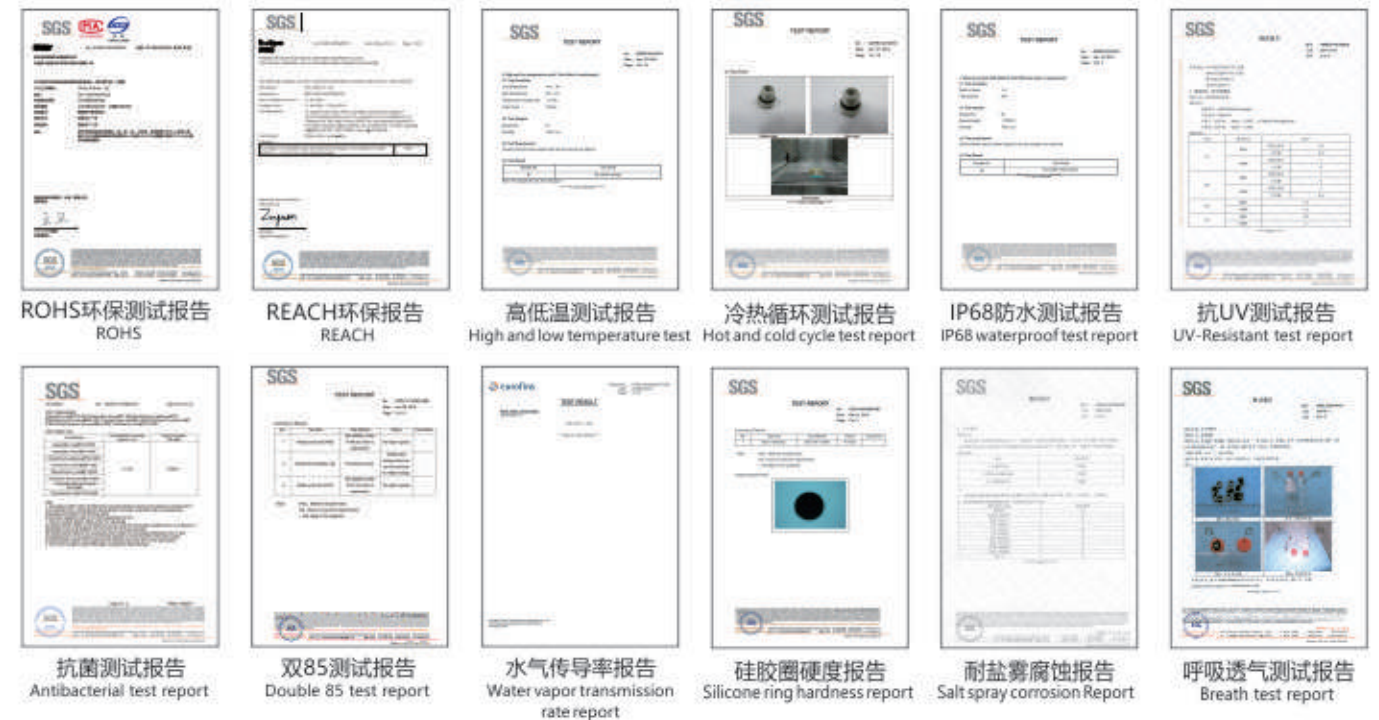



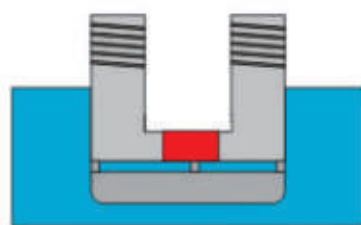

水 浸水示意图

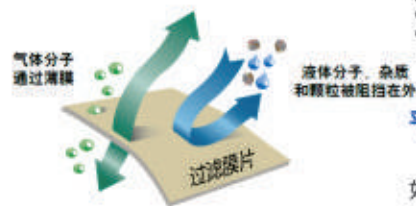

**透气和防护 Breathable and protective**

防水透气产品是集平衡压力、电池透氢和声音传输为一体的透气解决方案，能经济有效地解决设备使用过程中的水汽凝露、压力变化以及遭受恶劣环境影响等问题。防水透气产品在为设备有效阻挡灰尘和污垢的同时，又能保证设备在不断变化的环境条件下依然保持良好的透气性，从而避免设备内部因气体积聚而导致压力升高，造成壳体密封条损坏，使内部敏感电子元件遭受水和粉尘的侵袭。因此，防水透气产品能为敏感电子设备提供无与伦比的强大保护。

Waterproof and breathable products are air-permeable solutions that integrate balance pressure, battery hydrogen permeability and sound transmission. They can economically and effectively solve problems such as water vapor condensation, pressure changes, and adverse environmental impacts during the use of equipment. Waterproof and breathable products are effective in blocking dust and dirt from the equipment while ensuring that the equipment maintains good air permeability under changing environmental conditions, thereby avoiding pressure build-up in the equipment due to air accumulation, resulting in a housing seal Damage causes internal sensitive electronic components to suffer from water and dust. waterproof and breathable products can provide unmatched and powerful protection for sensitive electronic devices.

**平衡压力与消除凝露 Balance pressure and eliminate condensation**

所有在户外工作的电子电器产品外壳都经受着温度波动以及风、雨和阳光辐射的影响。例如，由一场暴风雨所引起的气温骤降可能导致壳体内部出现200mbar (3 psi) 的真空，最终把空气和水汽吸入设备内部，一旦水汽进入了密闭的壳体，若不及时去除，将会对敏感的电子元件产生腐蚀作用。防水透气产品有助于平衡壳体内外压力，防止空气和水分通过密封条进入壳体内部，并能有效保护密封条的完整性。透气膜还能加快水汽的扩散速度，从而减少壳体内部的水汽积聚，并能迅速消除壳体内部的凝露。

All electrical and electronic enclosures working outdoors are subject to temperature fluctuations and the effects of wind, rain, and sunlight. For example, a sudden drop in temperature caused by a storm may cause a 200 mbar (3 psi) vacuum inside the housing, eventually drawing air and water vapor into the equipment. Once the water vapor enters the closed casing, if it is not removed in time, it will have a corrosive effect on sensitive electronic components. Waterproof and breathable products help to balance the pressure inside and outside the housing, prevent air and moisture from entering the housing through the sealing strip, and can effectively protect the integrity of the sealing strip. The breathable membrane also accelerates the diffusion of ter vapor, thereby reducing the accumulation of water vapor inside the shell and rapidly eliminating the condensation within the shell.



**散热防水透气阀  
Datasheet**

订货编号 Article NO.	30205100126~9	30205100515~9	302015101451
产品照片 Picture			
产品型号 Type	POV-M12/HA	POV-M515/HB	STG-1451/HW
紧固结构 Fastening Structure	M12×1.5/M12×1.25	M5×1.5	M12×1.5
安装尺寸 Installation dimensions	见图1、安1 See drawing 1, See install figure 1	N/A	见图1、安1 See drawing 1, See install figure 1
紧固力矩 Tightening torque	0.6~0.8N.m	0.5~0.7N.m	0.6~0.8N.m
空气透过率(ml/min/1PSI) Typical airflow	400ml	200ml	400ml
水气传导率(g/24h) Water vapor transmission rate	0.2058±0.0001		
外形材质 Housing material	PA66+GF25FR	PA66+GF30	PA66+GF25FR
环保认证 Environmental protection certification	ROHS、REACH	ROHS、REACH	ROHS、REACH
抗菌等级GB/T2423.16 Antibacterial grade	N/A	N/A	1Level
抗UV等级ASTM G154-06 UV resistance level	UVA UVB1000h	UVA UVB1000h	UVA UVB1000h
阻燃等级UL-94 Flame retardant grade	V0, f1	V0, f1	V0, f1
抗盐雾性能 Salt spray resistance	10<0.1%	10<0.1%	10<0.1%
防护等级 Protection level	IP67	IP67	IP67
工作温度 Working temperature	-40°C~125°C	-40°C~125°C	-40°C~125°C

**防水通气阀  
Datasheet**



订货编号 Article NO.	30205501561	30205506708	30205508675
产品照片 Picture			
产品型号 Type	STG-1561/HW	STG-6708/HA	STG-8675/HZ
紧固结构 Fastening Structure	M12×1.5	M12×1.5	M12×1.5
安装尺寸 Installation dimensions	见图2、安2 See drawing 2, See install figure 2	见图1、安1 See drawing 1, See install figure 1	见图2、安2 See drawing 2, See install figure 2
紧固力矩 Tightening torque	0.6~0.8N.m	0.6~0.8N.m	0.6~0.8N.m
空气透过率(ml/min/1PSI) Typical airflow	550ml	2500~3000ml	1700ml
水气传导率(g/24h) Water vapor transmission rate	0.2058±0.0001	0.3106±0.0001	0.2815±0.0001
外形材质 Housing material	PA66+GF30	PA66+GF25FR	PA66+GF25FR
环保认证 Environmental protection certification	ROHS、REACH	ROHS、REACH	ROHS、REACH
抗菌等级GB/T2423.16 Antibacterial grade	1Level		
抗UV等级ASTM G154-06 UV resistance level	UVA UVB1000h	UVA UVB1000h	UVA UVB1000h
阻燃等级UL-94 Flame retardant grade	V0, f1	V0, f1	V0, f1
抗盐雾性能 Salt spray resistance	10<0.1%	10<0.1%	10<0.1%
防护等级 Protection level	IP67/IP68/IP69	IP66/IP67	IP67/IP68/IP69
工作温度 Working temperature	-40°C~125°C	-40°C~125°C	-40°C~125°C

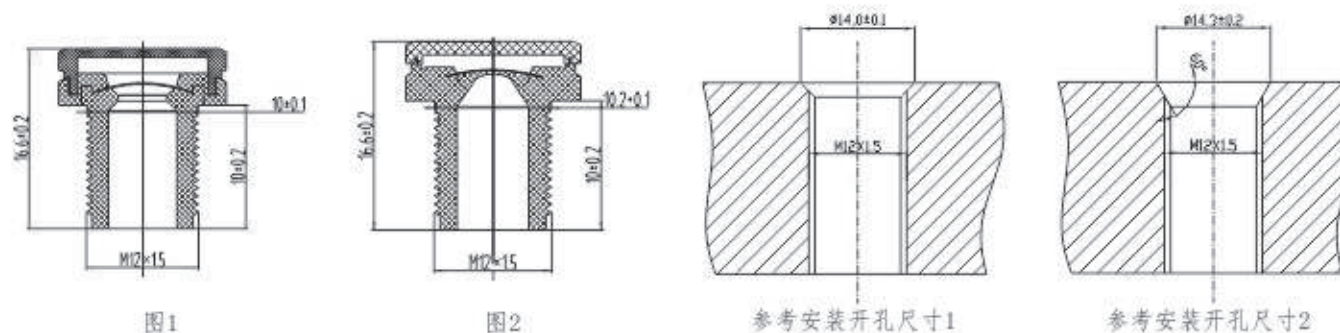





订货编号 Article NO.	30205902730	30205902830	30205100012
产品照片 Picture			
产品型号 Type	STG-2730/HW	STG-2830/HW	SUS-M12/HD
紧固结构 Fastening Structure	M24×1.5	M24×1.5	M12×1.5
安装尺寸 Installation dimensions	见图3、详见规格书 See drawing 3, Details see datasheet	见图3、详见规格书 See drawing 3, Details see datasheet	详见规格书 Details see datasheet
紧固力矩 Tightening torque	0.7~0.8N.m	0.7~0.8N.m	0.8~1.0N.m
空气透过率(ml/min/1PSI) Typical airflow	15000ml	20000ml	400ml/1700ml
水气传导率(g/24h) Water vapor transmission rate	0.2815±0.0001	0.3106±0.0001	0.2058±0.0001
外形材质 Housing material	PA66+GF25FR	PA66+GF25FR	SUS304
环保认证 Environmental protection certification	ROHS、REACH	ROHS、REACH	ROHS、REACH
抗菌等级GB/T2423.16 Antibacterial grade	1Level		N/A
抗UV等级ASTM G154-06 UV resistance level	UVA UVB1000h	UVA UVB1000h	N/A
阻燃等级UL-94 Flame retardant grade	V0, f1	V0, f1	N/A
抗盐雾性能 Salt spray resistance	10<0.1%	10<0.1%	N/A
防护等级 Protection level	IP67	IP66/IP67	IP67/
工作温度 Working temperature	-40°C~125°C	-40°C~125°C	-80°C~190°C



图3



图4

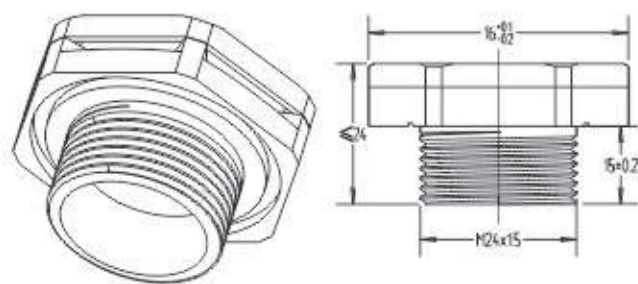

订货编号 Article NO.	30205101220	30205400129	30205501215
产品照片 Picture			
产品型号 Type	SST-1220/ZT	SSA-1052/CS	HWZ-M1215/H
紧固结构 Fastening Structure	M12×1.5	卡扣 Buckle	M12×1.5
安装尺寸 Installation dimensions	详见规格书 Details see datasheet	见图4、详见规格书 See drawing 4, Details see datasheet	详见规格书 Details see datasheet
紧固力矩 Tightening torque	0.6~0.8N.m	N/A	0.6~0.8N.m
空气透过率(ml/min/1PSI) Typical airflow	400ml/1700ml	200ml/400ml/1700ml	400ml/1700ml
水气传导率(g/24h) Water vapor transmission rate	0.2815±0.0001	0.2015±0.0001	0.2670±0.0001
外形材质 Housing material	PA66+GF25FR	PA66+GF30	PA66+GF25+PC
环保认证 Environmental protection certification	ROHS、REACH	ROHS、REACH	ROHS、REACH
抗菌等级GB/T2423.16 Antibacterial grade	1Level	N/A	N/A
抗UV等级ASTM G154-06 UV resistance level	UVA UVB1000h	UVA UVB1000h	N/A
阻燃等级UL-94 Flame retardant grade	V0, f1	N/A	V0, f1
抗盐雾性能 Salt spray resistance	10<0.1%	10<0.1%	N/A
防护等级 Protection level	IP67/IP68	IP68/IP69	IP67
工作温度 Working temperature	-40°C~125°C	-40°C~125°C	-40°C~125°C

## 散热防水呼吸器产品部分应用领域

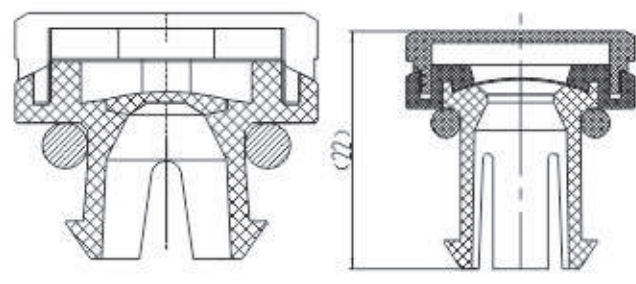
Application domain of heat dissipation and waterproof respirator

 户外灯具  
Outdoor lighting

 发动机传感控制箱  
Engine sensor control box

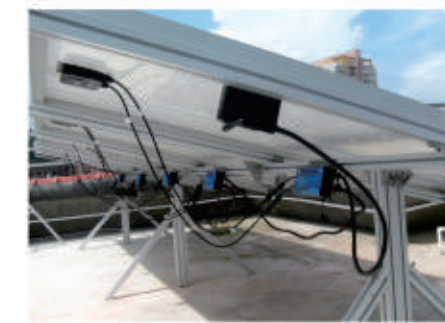
 太阳能逆变器  
Solar inverter



**防水透气膜和亲水过滤膜系列**

Waterproof and breathable membrane and hydrophilic membranes series



订货编号 Article NO.	30207001050	30207008750	30209106710
产品照片 Picture			
产品型号 Type	GGT-1050/AX	GTZ-8750/ZS	STQ-M6710/QS
过滤性能 Filtration performance	防水透气/永久功能过滤 Waterproof breathable/ permanent filtering functions	防水透气/永久功能过滤/永久亲水 Waterproof breathable/filter/ permanent hydrophilic permanent function	M6×1.5
产品材质 Product material	PTFE/FVDF	PTFE/FVDF	PTFE
表面特性 Surface properties	疏水/超疏水/疏油 Hydrophobic/super hydrophobic/thin oil	疏水/疏油/亲水 Hydrophobic/thin oil/water	亲水、过滤 Water, filtering
微孔孔径 Air transmission rate	0.2/0.4/0.7/1.0/1.5/2.0/5.0μm	0.2/0.4/0.7/1.0/1.5/2.0/5.0μm	N/A
第一泡点 (MPa) The first bubble	0.035/0.041/0.070/0.120/1.50	0.035/0.041/0.070/0.120/1.50	N/A
支撑材料 Reinforcing material	GF/PP/PET/PPT	SUS/PC/DM	PC/PP/PE
环保认证 Environmental protection certification	ROHS, REACH	ROHS, REACH	ROHS, REACH
加工处理 Processing	模切/背胶/热压/熔接 Die cutting/lamination/hot/welding	背胶/熔接/热覆 Back glue/welding/hot	热熔/热压/注塑 Hot melt/compression/injection molding
工作温度 Working temperature	-80°C~265°C	-80°C~220°C	-40°C~120°C

**防水通气产品部分应用领域**

Part of the application field of waterproof ventilation products

 通讯放大器  
Telecommunication amplifier

 基站信号中转站  
Base station signal relay station

 通讯雷达电气控制箱  
Telecommunication radar electrical control box

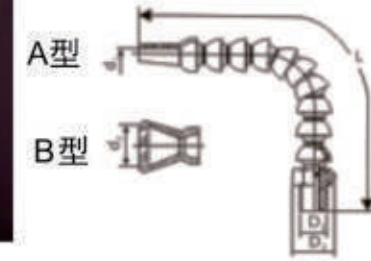
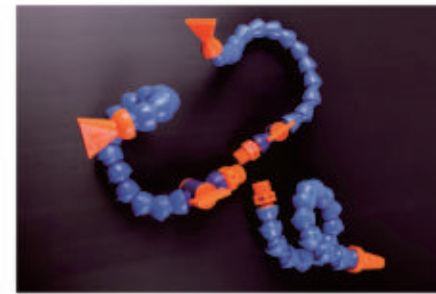
**SSCT系列**
**塑料冷却水管 Plastic Cooling Tube**

材质: POM 聚甲醛

适用于机床上喷冷却水

Material: POM

Spray cooling water is for the machine.

订货号 Article No.	螺纹 Thread	喷嘴尺寸 d1 (mm) d2 (mm)		螺纹外径 D1 (mm)	扳手尺寸 D2 (mm)	长度 Length (mm)	备注 Remark
SSCT-G1/4	G1/4"	1.5	23	12	14	13	订货时请备注是否带要带开关阀。 Please notice whether or not with valve when you place the order.
		3					
		4					
SSCT-G3/8	G3/8"	2	30	15.5	19	17.5	
		5					
SSCT-G1/2	G1/2"	4.5	40	19.5	23	21	水管的长度可按照客户需求定制。 We can custom make the special length.
		9					
		11.5					

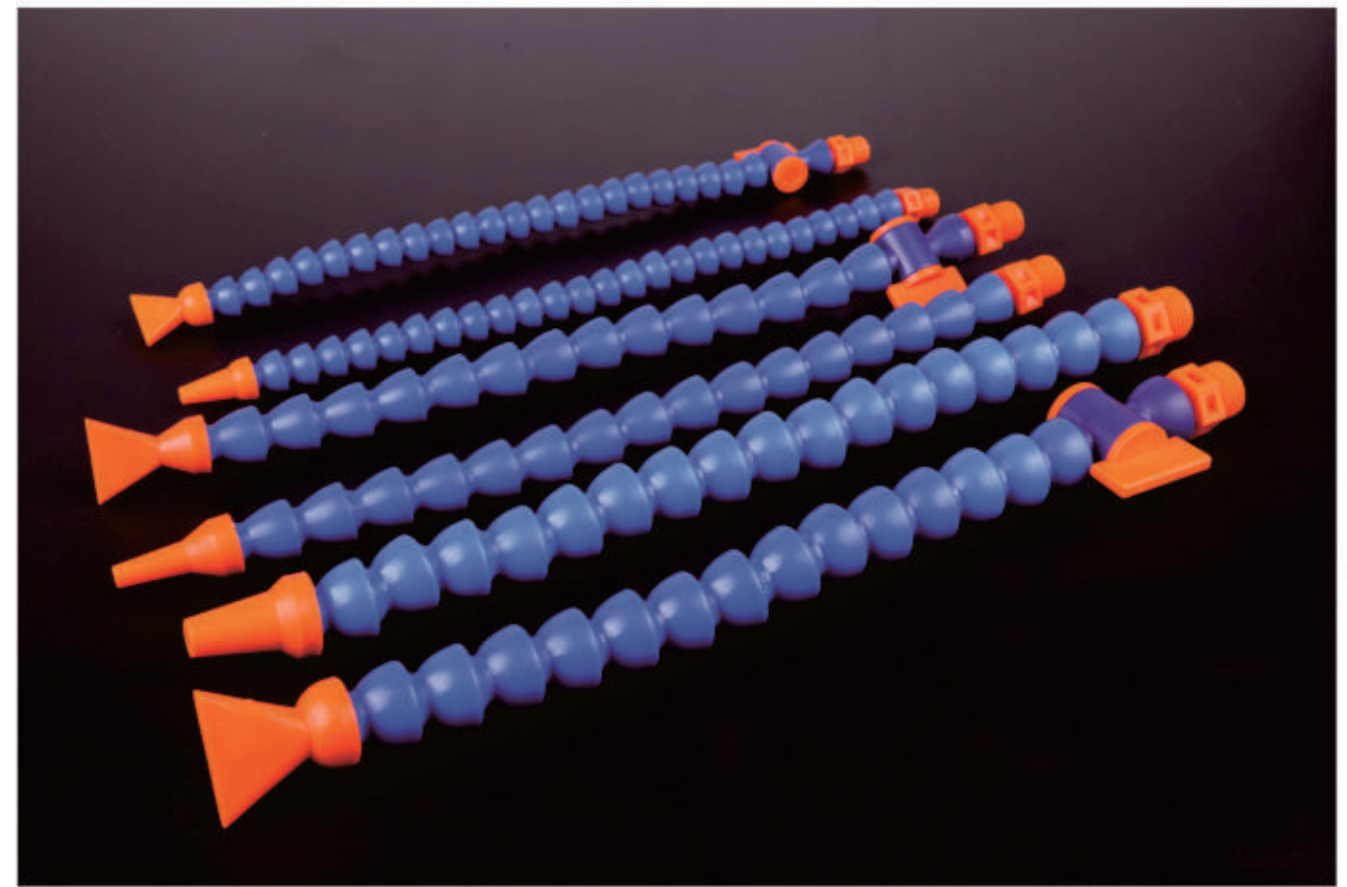



## 附录 Appendix

## 螺纹标准与技术数据 Thread standard and technical data

公制螺纹: 螺牙角度 60 度 Metric Thread:60°

螺纹规格	螺距	外径 d1	底径 d2	备注
thread	Pitch	mm	mm	
M10	1	10	9	欧标、国标
M12	1.5	12	10.5	欧标、国标
M16	1.5	16	14.5	欧标、国标
M18	1.5	18	16.5	国标
M20	1.5	20	18.5	欧标、国标
M22	1.5	22	20.5	国标
M24	1.5	24	22.5	国标
M25	1.5	25	23.5	欧标
M27	2	27	25	国标
M30	2	30	28	国标
M32	1.5	32	30.5	欧标、国标
M33	2.0	33	31.0	国标
M36	2	36	34	国标
M40	1.5	40	38.5	欧标、国标
M42	2.0	42	40	国标
M48	2	48	46	国标
M50	1.5	50	48.5	欧标、国标
M56	2	56	54	国标
M60	2	60	58	国标
M63	1.5	63	61.5	欧标、国标
M64	2	64	62	国标

管螺纹: 螺牙角度 55 度 G Thread:55°

螺纹规格	螺距	螺纹外径 d	内螺纹小径
thread	Pitch	mm	mm
G 1/4"	1.337	13.157	11.145
G 3/8"	1.337	16.662	14.950
G 1/2"	1.814	20.995	18.631
G 3/4"	1.814	26.441	24.117
G 1"	2.309	33.249	30.291
G 1 1/4"	2.309	41.910	38.952
G 1 1/2"	2.309	47.803	44.845
G 2"	2.309	59.614	56.565
G2 1/2"	2.309	75.184	72.226
G 3"	2.309	87.884	84.926

G 螺纹标准按: DIW ISO 228-1

Gas thread standard according to DIN ISO 228-1

德国 PG 制螺纹: 螺牙角度 80 度 PG Thread:80°

螺纹规格	螺距	外径 d1	底径 d2
thread	Pitch	mm	mm
PG7	1.27	12.5	11.28
PG9	1.41	15.2	13.86
PG11	1.41	18.6	17.26
PG13.5	1.41	20.4	19.06
PG16	1.41	22.5	21.16
PG21	1.587	28.3	26.78
PG29	1.587	37	35.48
PG36	1.587	47	45.58
PG42	1.587	54	52.48
PG48	1.587	59.3	57.78

注明: 欧州公制标准按照 EN60423 标准

国标公制标准按照 GB/T192-1981

PG 螺纹标准按照 DIN40430

Notice: European metric thread standard according to EN60423, Chinese metric thread standard according to GB/T 192-1981

PG thread standard DIN 40430

NPT 锥管螺纹: 螺牙角度 60 度 NPT Thread:60°

螺纹规格	螺距	基面螺纹大径	内螺纹小径
thread	Pitch	mm	mm
NPT 1/4"	1.411	13.616	11.358
NPT 3/8"	1.411	17.055	14.797
NPT 1/2"	1.814	21.223	18.321
NPT 3/4"	1.814	26.568	23.666
NPT 1"	2.208	33.228	29.694
NPT 1 1/4"	2.208	41.988	38.451
NPT 1 1/2"	2.208	48.054	44.520
NPT 2"	2.208	60.092	56.558
NPT 2 1/2"	3.175	72.699	67.619
NPT 3"	3.175	88.608	83.528

NPT 螺纹标准按: ANSI/ASME B1.20.

NPT thread standard according to ANSI/ASME B1.20./

## 电缆防水接头扭矩标准 VDE0619 cable gland twisting standard for torque moment

螺纹规格	夹紧接头 cable gland		螺母 lock nut	
	塑料	金属	塑料	金属
thread	plastic	metal	plastic	metal
dimension				
Pg7/M12	2.5	6.25	1.67	4.17
Pg9/M16	3.75	6.25	2.5	4.17
Pg11/M18	3.75	6.25	2.5	4.17
Pg13.5/M20	3.75	6.25	2.5	4.17
Pg16/M22/M24	5	7.5	3.33	5
Pg21/M25/M27/M30	7.5	10	5	6.67
Pg29/M32/M33/M36	7.5	10	5	6.67
Pg36/M40/M42/M48	7.5	10	5	6.67
Pg42/M50/M56	7.5	10	5	6.67
Pg48/M63/M64	7.5	10	5	6.67

单位: N·M UNIT: N·M

## IP 防护等级的意义 Protection Degree

## 第一位表示防尘指标

0. 表示没有防护
1. 可防止 50mm 以上固体的危害。(偶然的手接触)
2. 可防止 12mm 以上固体的危害。(手指大小的物体)
3. 可防止 2.5mm 以上固体的危害。(细电线等)
4. 可防止 1mm 以上固体的危害。(细电线等)
5. 可防止粉尘的危害。
6. 完全防止粉尘的危害。

## First index

## Code Degree of protection (dust)

0. No protection
1. Protection against foreign bodies with  $\phi > 50\text{mm}$  (occasional contact with hands)
2. Protection against foreign bodies with  $\phi > 12\text{mm}$  (occasional contact with fingers)
3. Protection against foreign bodies with  $\phi > 2.5\text{mm}$  (wires or the like with  $\phi > 2.5\text{mm}$ )
4. Protection against foreign bodies with  $\phi > 1\text{mm}$  (wires or the like with  $\phi > 1\text{mm}$ )
5. Protection against dust
6. Full protection against dust

## 第二位表示防水指标

0. 表示没有防护
1. 可防止垂直落水的危害
2. 可防止垂直方向成 15° 角以下直接喷水的危害
3. 可防止垂直方向成 60° 角以下直接喷水的危害
4. 可防止来自各个方向上直接喷水的危害
5. 可防止来自各个方向上低压水喷射的危害
6. 可防止来自各个方向上高压水喷射的危害
7. 可防止 15cm~1m 之间浸没的危害
8. 可防止在 >1m 压力下长期浸没的危害

## Second index

## Code Degree of protection (water)

0. No protection
1. Protection against vertical water drops
2. Protection against included water drops (any angle up to 15° to vertical line)
3. Protection against splash water from all directions, 60° to vertical line
4. Protection against splash water from all directions.
5. Protection against water jets from any angle under low pressure
6. Protection against water jets from any angle under high pressure
7. Protection against water penetration 15cm~1m below water
8. Protection against long-term water penetration >1m below water



**UL94 标准 — 技术说明****UL94 HB**

试验材料在水平测试中应该燃烧缓慢，厚度不超过 3mm 时的燃烧速度不能超过 3 英寸/分钟 (7.6mm/分钟)；厚度大于 3mm 时的速度不能超过 1.5 英寸/分钟 (3.8mm/分钟)；超过此燃烧速度的任何材料均不能获得 UL 认可。

**UL94 V2**

在垂直燃烧试验中，平均自熄时间不能超过 25 秒 (单次时间不能超过 30 秒)，燃烧产生的滴落物可能引燃下方的棉物。

点燃后，任何可能的燃烧时间均不能超过 60 秒。

**UL94 V1**

在垂直燃烧试验中，平均自熄时间不能超过 25 秒 (单次时间不能超过 30 秒)，燃烧产生的滴落物不可以引燃下方的棉物。

点燃后，任何可能的燃烧时间均不能超过 30 秒。

**UL94 V0**

在垂直燃烧试验中，平均自熄时间不能超过 5 秒 (单次时间不能超过 10 秒)，燃烧产生的滴落物不能引燃下方的棉物。

点燃后，任何可能的燃烧时间均不能超过 30 秒。

**德国 S4 标准 (根据 DIN5510) — 技术说明**

耐火等级 S4 — 测试过程按 DIN54837 标准

要求：破坏长度 ≤ 20cm，无燃烧情况

如果试验区的样品点燃后的燃烧平均时间不超过 10 秒，也可以认为该产品达到了 S4 等级；如果任何非试验区里的样品产生燃烧则不能认为该产品达到 S4 等级。

如果试验区样品的燃烧时间超过 120 秒，则不能认为该产品达到了 S4 等级 (根据 DIN54837 标准，样品必须在点燃后 120 秒内自熄)。

**常见国家标准和认证**

欧共体安全标准  
Europe committee



美国和加拿大共同认可的  
UL (Underwriter Lab) 列表标志



中国国家强制性认证



德国 EMC 电磁兼容



UL 认证标志

CSA

加拿大国家标准

VDE

德国电气协会标准

DIN

德国国家工业标准

GB

中国国家标准

**订货须知****1. 订货方式:**

电话/网络 (邮件、QQ、微信、阿里诚信通等)。

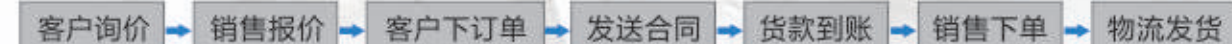
**2. 首批订货流程:****3. 产品报价:**

含16%税率，不含运费。

**4. 订货数量:**

请按照产品最小包装量起订，具体包装数量详见产品规格说明或来电咨询。

**5. 产品包装:**

接头类产品，内包装为塑料袋，外包装为标准纸箱。波纹软管内包装为缠绕薄膜，外包装为编织袋。如需特殊包装要求，请联系销售专员。

**6. 发货时间及周期:**

有库存产品，当天下午3:00之前下单，当天可以发货。定制产品，发货周期按双方约定时间。

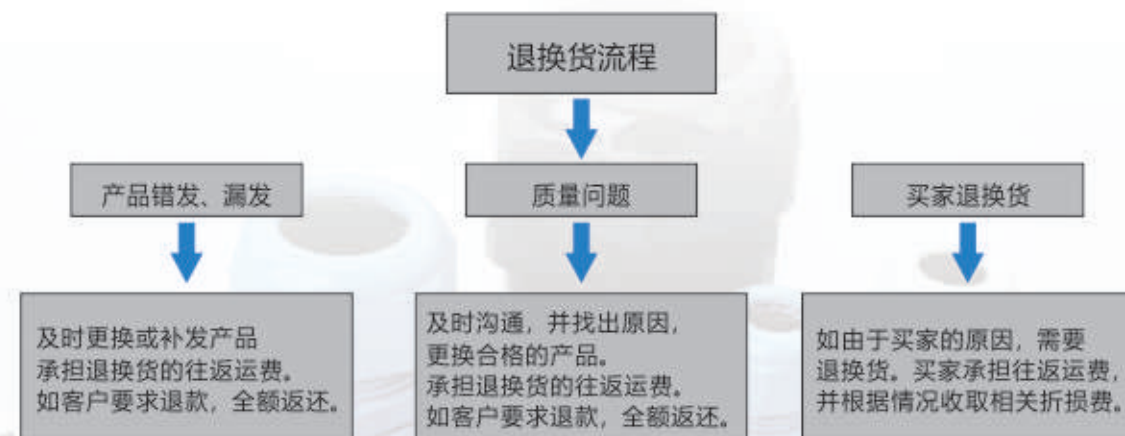
**7. 退换货流程:****8. 发货方式**

江浙沪地区均发快递，其他省市根据货物数量，体积大小选择合适的物流或专线。如需指定运输，请联系销售专员。